

Product catalogue

PREMIUM

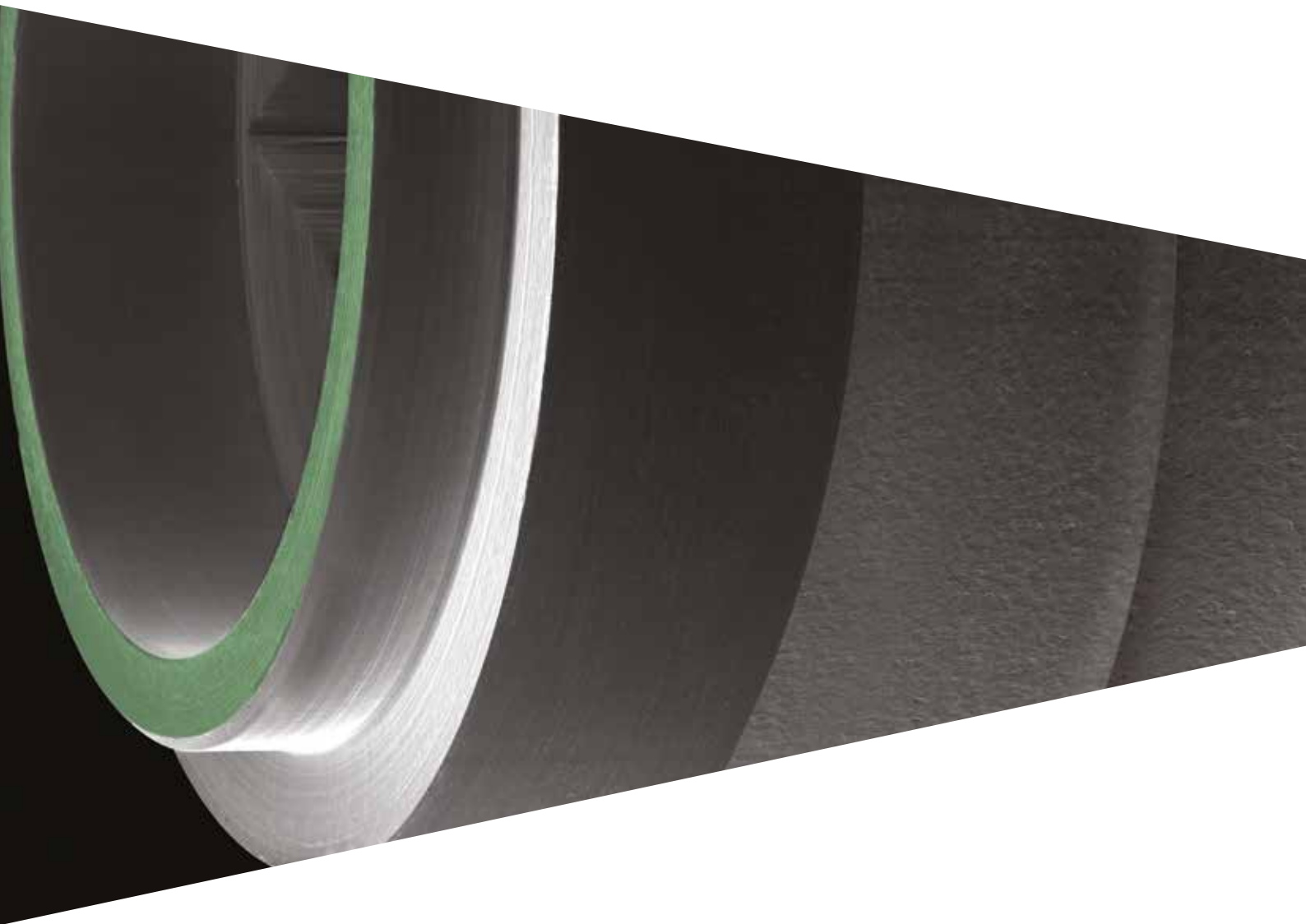

Some products may not be regulatory cleared/released for sale in all markets.  
Please contact the local Sweden & Martina or distributor sales office for current products availability.

# Premium

## Table of contents



### Complete range of Premium implants

Morphology of Premium implants	8
ZirTi surface	10
Availability	11
Premium Straight and Premium SP connections	14
Platform Switching	16
Premium TG	18
Mountless surgical procedure	22



### Surgical instruments

The surgical and prosthetic kits	26
Surgical kit	27
OneBox	28
Screw kit	29
Initial, intermediate and countersink drills	30
Final drills and stops	32
Drills for distal sectors	34
Osteotomes	36
Bone taps	37
Additional instruments	38
Bone profilers	45
Shorty drilling kit	46



### Premium Straight and SP prosthetic components

Healing abutments	52
Impression and model phase	54
SIMPLE temporary posts	58
Pre-made posts	60
Standard millable posts	64
Millable posts	66
B.O.P.T. prosthesis	68
Castable posts with base in alloy, titanium and cobalt chrome	70
Prosthesis on intermediate abutments	72
P.A.D. (Disparallel Screwed Prosthesis)	74
Straight P.A.D.	76
Angled P.A.D.	77
P.A.D. components for the relined and the cemented technique	81
P.A.D. prosthesis for "D.P.F." Technique (Direct Prosthetic Framework)	82
Prosthesis on PLAIN abutments	84
T-Connect	86
Try-in kit	88



## Overdenture for Premium Straight and SP implants 90

Locator Abutment	92
Overdentures anchored with ball attachments	94
SFI-Bar	96



## Premium TG (Transgingival) prosthetic components with fixation screw 100

Healing abutments for TG implants	102
Impression and model phase	104
SIMPLE temporary posts	106
Pre-made straight posts	108
Angled pre-made posts	110
Standard millable posts	112
Castable posts with alloy base	114
Prosthesis on intermediate abutments	116
T-Connect	120



## Premium TG (Transgingival) prosthetic components, direct screw-retained 122

Solid one-piece abutments	124
Prosthesis on intermediate abutments	128



## Premium TG (Transgingival) Overdentures 130

Locator abutments	132
Overdentures anchored with ball attachments	134



## Common prosthetic components

Accessories for overdentures on Locator abutments

Accessories for overdentures on ball attachments

Overdentures on bars

136

138

140

141





# Morphology of Premium implants

The different morphologies that characterise the entire family of Premium implants Straight, Platform Switching "SP" and Transgingival "TG" mean that the correct implant design can always be selected to suit the site in which they are to be fitted.

## Ø 3.30

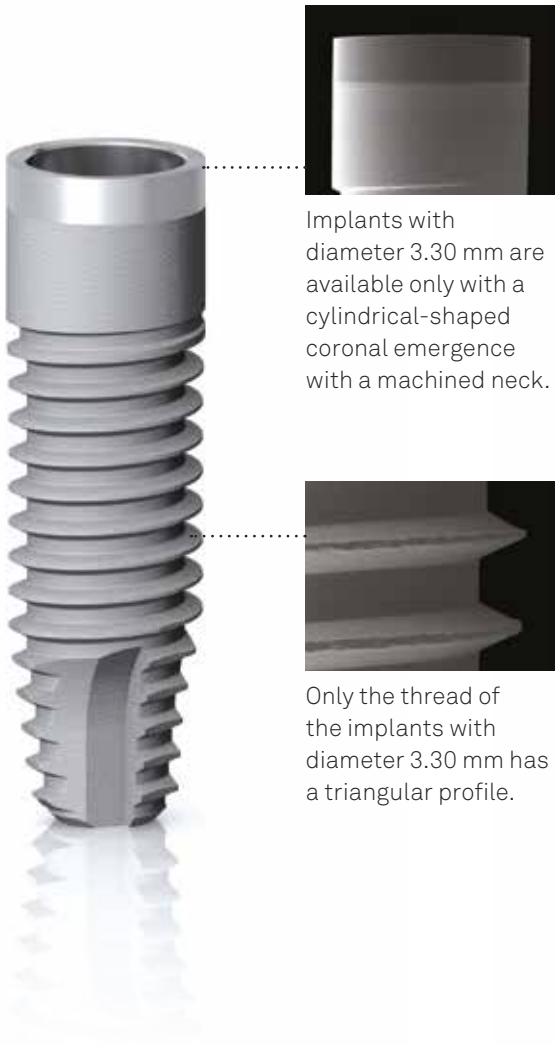

Implants with diameter 3.30 mm are available only with a cylindrical-shaped coronal emergence with a machined neck.

Only the thread of the implants with diameter 3.30 mm has a triangular profile.

## Straight

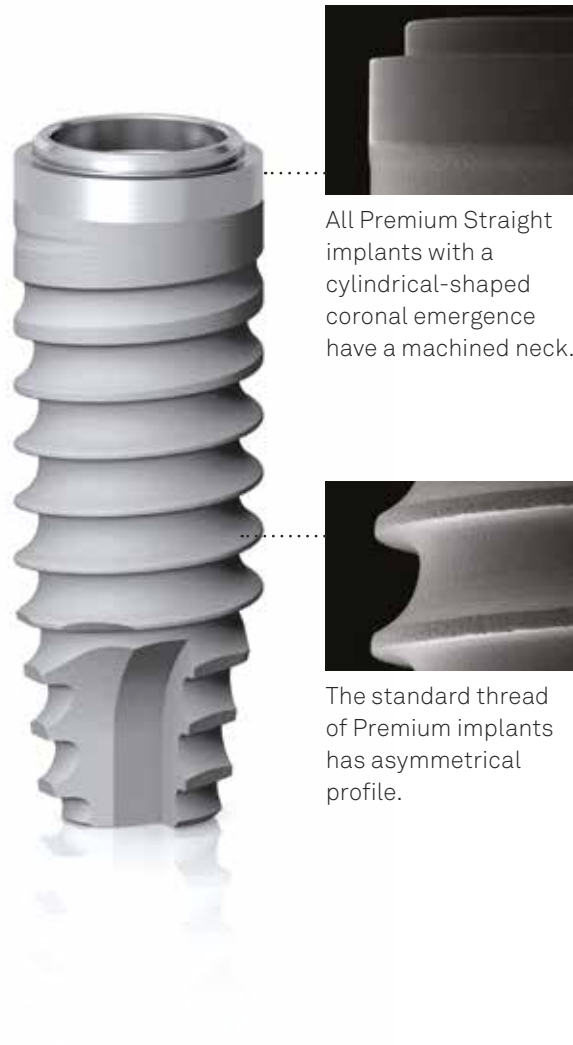

All Premium Straight implants with a cylindrical-shaped coronal emergence have a machined neck.

The standard thread of Premium implants has asymmetrical profile.



### Platform Switching

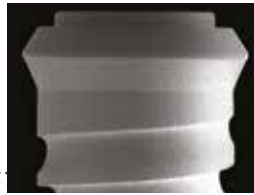

The neck of Premium SP implants widens gradually in the coronal direction, then returns to the implant diameter at connection level.

### Transgingival



The height of the transgingival part of Premium TG implants is the same in all endosseous length of the implant.



Premium TG implants have a rounded apical profile.



All Premium implants have three apical cutting notches that increase the penetrating capacity and ensure a good self-threading capability.

# ZirTi surface

All three versions of Premium implants Straight, SP and TG are available with a machined neck and a body with ZirTi treatment.



## Machined surface

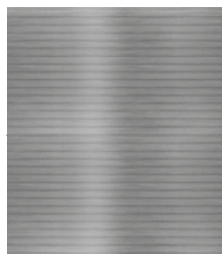

The machined neck allows the control of the connection diameter and prevents the accumulation of plaque in the area where it joins the post.

## ZirTi surface

(Zirconium Sand-Blasted Acid Etched Titanium)

The implant body is treated with appropriate subtraction techniques that give the surface the characteristic ZirTi morphology.

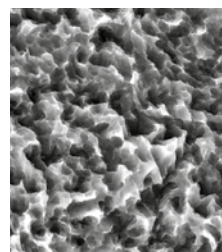





















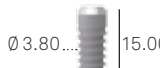









*Image from the Sweden & Martina archives*

































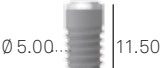



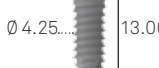

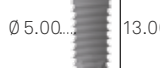
# Availability

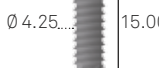
		PREMIUM	PREMIUMSP	PREMIUMTG
				
diameter	length	code	code	code
3.30	10.00	A-ZT-330-100	-	A-ZT-330TG-100
	11.50	A-ZT-330-115	-	A-ZT-330TG-115
	13.00	A-ZT-330-130	-	A-ZT-330TG-130
	15.00	A-ZT-330-150	-	A-ZT-330TG-150
3.80	6.00	-	-	A-ZT-380TG-060
	7.00	-	-	A-ZT-380TG-070
	8.50	A-ZT-380-085	A-ZT-380SP-085	A-ZT-380TG-085
	10.00	A-ZT-380-100	A-ZT-380SP-100	A-ZT-380TG-100
	11.50	A-ZT-380-115	A-ZT-380SP-115	A-ZT-380TG-115
	13.00	A-ZT-380-130	A-ZT-380SP-130	A-ZT-380TG-130
	15.00	A-ZT-380-150	A-ZT-380SP-150	A-ZT-380TG-150
	18.00	A-ZT-380-180	-	-
4.25	6.00	-	-	A-ZT-425TG-060
	7.00	A-ZT-425-070	A-ZT-425SP-070	A-ZT-425TG-070
	8.50	A-ZT-425-085	A-ZT-425SP-085	A-ZT-425TG-085
	10.00	A-ZT-425-100	A-ZT-425SP-100	A-ZT-425TG-100
	11.50	A-ZT-425-115	A-ZT-425SP-115	A-ZT-425TG-115
	13.00	A-ZT-425-130	A-ZT-425SP-130	A-ZT-425TG-130
	15.00	A-ZT-425-150	A-ZT-425SP-150	A-ZT-425TG-150
	18.00	A-ZT-425-180	-	-
5.00	6.00	-	-	A-ZT-500TG-060
	7.00	A-ZT-500-070	A-ZT-500SP-070	A-ZT-500TG-070
	8.50	A-ZT-500-085	A-ZT-500SP-085	A-ZT-500TG-085
	10.00	A-ZT-500-100	A-ZT-500SP-100	A-ZT-500TG-100
	11.50	A-ZT-500-115	A-ZT-500SP-115	A-ZT-500TG-115
	13.00	A-ZT-500-130	A-ZT-500SP-130	A-ZT-500TG-130
15.00	A-ZT-500-150	A-ZT-500SP-150	A-ZT-500TG-150	

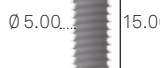
The Premium Straight, Premium SP and Premium TG range

	3.30 mm			3.80 mm		
	Straight	SP	TG	Straight	SP	TG
6.00	-	-	-	-	-	<b>A-ZT-380TG-060</b> 
7.00	-	-	-	-	-	<b>A-ZT-380TG-070</b> 
8.50	-	-	-	<b>A-ZT-380-085</b> 	<b>A-ZT-380SP-085</b> 	<b>A-ZT-380TG-085</b> 
10.00	<b>A-ZT-330-100</b> 	-	<b>A-ZT-330TG-100</b> 	<b>A-ZT-380-100</b> 	<b>A-ZT-380SP-100</b> 	<b>A-ZT-380TG-100</b> 
11.50	<b>A-ZT-330-115</b> 	-	<b>A-ZT-330TG-115</b> 	<b>A-ZT-380-115</b> 	<b>A-ZT-380SP-115</b> 	<b>A-ZT-380TG-115</b> 
13.00	<b>A-ZT-330-130</b> 	-	<b>A-ZT-330TG-130</b> 	<b>A-ZT-380-130</b> 	<b>A-ZT-380SP-130</b> 	<b>A-ZT-380TG-130</b> 
15.00	<b>A-ZT-330-150</b> 	-	<b>A-ZT-330TG-150</b> 	<b>A-ZT-380-150</b> 	<b>A-ZT-380SP-150</b> 	<b>A-ZT-380TG-150</b> 
18.00	-	-	-	<b>A-ZT-380-180</b> 	-	-
surgical cover screws	<b>A-VT-330</b> 	Use A-VT-330	<b>A-TG-VT-M</b> 	<b>A-VT-380</b> 	Use A-VT-380	<b>A-TG-VT-M</b> 

- Ø 3.30 mm implants: The use of the Premium Ø 3.30 mm implants is only for replacing the central and lateral incisors and upper and lower canine teeth. They can also be used in the pre-molar and molar zone, but only to support the prosthetic structures which are also supported by implants with a bigger diameter.

	4.25 mm			5.00 mm		
	Straight	SP	TG	Straight	SP	TG
6.00	-	-	<b>A-ZT-425TG-060</b> 	-	-	<b>A-ZT-500TG-060</b> 
7.00	<b>A-ZT-425-070</b> 	<b>A-ZT-425SP-070</b> 	<b>A-ZT-425TG-070</b> 	<b>A-ZT-500-070</b> 	<b>A-ZT-500SP-070</b> 	<b>A-ZT-500TG-070</b> 
8.50	<b>A-ZT-425-085</b> 	<b>A-ZT-425SP-085</b> 	<b>A-ZT-425TG-085</b> 	<b>A-ZT-500-085</b> 	<b>A-ZT-500SP-085</b> 	<b>A-ZT-500TG-085</b> 
10.00	<b>A-ZT-425-100</b> 	<b>A-ZT-425SP-100</b> 	<b>A-ZT-425TG-100</b> 	<b>A-ZT-500-100</b> 	<b>A-ZT-500SP-100</b> 	<b>A-ZT-500TG-100</b> 
11.50	<b>A-ZT-425-115</b> 	<b>A-ZT-425SP-115</b> 	<b>A-ZT-425TG-115</b> 	<b>A-ZT-500-115</b> 	<b>A-ZT-500SP-115</b> 	<b>A-ZT-500TG-115</b> 
13.00	<b>A-ZT-425-130</b> 	<b>A-ZT-425SP-130</b> 	<b>A-ZT-425TG-130</b> 	<b>A-ZT-500-130</b> 	<b>A-ZT-500SP-130</b> 	<b>A-ZT-500TG-130</b> 
15.00	<b>A-ZT-425-150</b> 	<b>A-ZT-425SP-150</b> 	<b>A-ZT-425TG-150</b> 	<b>A-ZT-500-150</b> 	<b>A-ZT-500SP-150</b> 	<b>A-ZT-500TG-150</b> 
18.00	<b>A-ZT-425-180</b> 	-	-	-	-	-
surgical cover screws	<b>A-VT-425</b> 	Use A-VT-425	<b>A-TG-VT-M</b> 	<b>A-VT-500</b> 	Use A-VT-500	<b>A-TG-VT-W</b> 

# Premium Straight and Premium SP connections

Premium cylindrical implants, in both the version with Straight cylindrical emergence and the version with SP enlarged emergence, have a common connection platform, thus facilitating the task of the restoring doctor.

**Straight**



**SP**



## **Bevel**

The widening generated by the bevel in SP implants allows the crestal bone to be distanced from the implant connection in a horizontal and in a vertical direction, thus offering a Platform Switching embedded in the morphology of the implant.

## **Collar**

Implants with a diameter greater than 3.30 mm have a collar on top of the neck that gives great maximum stability to the connection and aids the correct distribution of the masticatory forces, which are unloaded along the entire implant perimeter. It also creates a stabilising connection for the post, capable of reducing medial-distal and lingual-buccal movements.

The internal part of the collar allows safe and easy engaging of the insertion drivers.

## **Internal hexagon for repositioning of the prosthesis**

Located in a coronal position, it is characterised by excellent visibility. The 60° repositioning and the total connection depth provides non-rotation and precision.

**Premium connection Ø 3.30 mm**



**Collar**

In Premium implants with diameter 3.30 mm, the internal collar performs the same prosthesis stabilising function performed by the external collar in all the other implant diameter dimensions.

**Internal hexagon for repositioning of the prosthesis**

Located in a coronal position, it is characterised by excellent visibility. The 60° repositioning and the total connection depth ensure non-rotation and precision. The dimensions of the hexagon are the same as in Ø 3.80 mm implants.

**Connection similarities**

Same hexagon, but in diameter 3.30 the collar is inside the platform.



*Premium Ø 3.30 mm*



*Premium Ø 3.80 mm*



*Premium Ø 4.25 mm*



*Premium Ø 5.00 mm*

In these implant diameters the hexagon is the same, the internal diameter of the collar on top of the hexagon is the same, but it widens externally in the different diameters.

# Platform Switching

The Platform Switching is a prosthetic rehabilitation technique that aims to distance the prosthetic connection platform from the cervical bone.

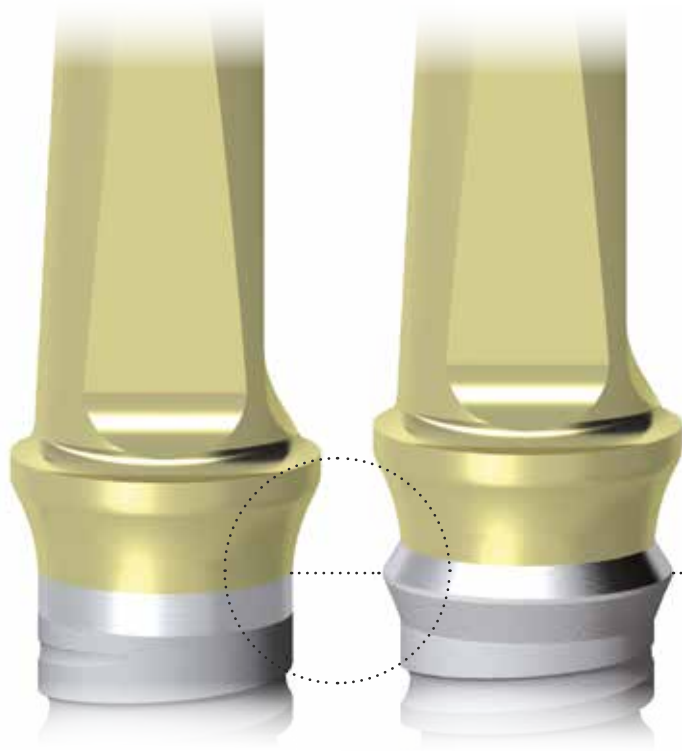

Diameters being equal, implants with Straight emergence and Platform Switching emergence use the same prosthetic components. The Platform Switching technique used in this case is incorporated in the implant morphology.



## Platform Switching on Straight implants $\varnothing$ 3.80 mm

It is still possible to employ a prosthetic Platform Switching on implants with diameter 3.80 mm, using a post with a smaller diameter (3.30 mm).



With this configuration the Platform Switching can be obtained on all sides.



### Platform Switching on SP implants Ø 3.80 mm

For maximising mismatching between the level of the bone crest and the join between implant and prosthesis, the combined use of an SP implant and a post with a smaller diameter, as in the drawing below, allows you to obtain a highly accentuated Platform Switching.

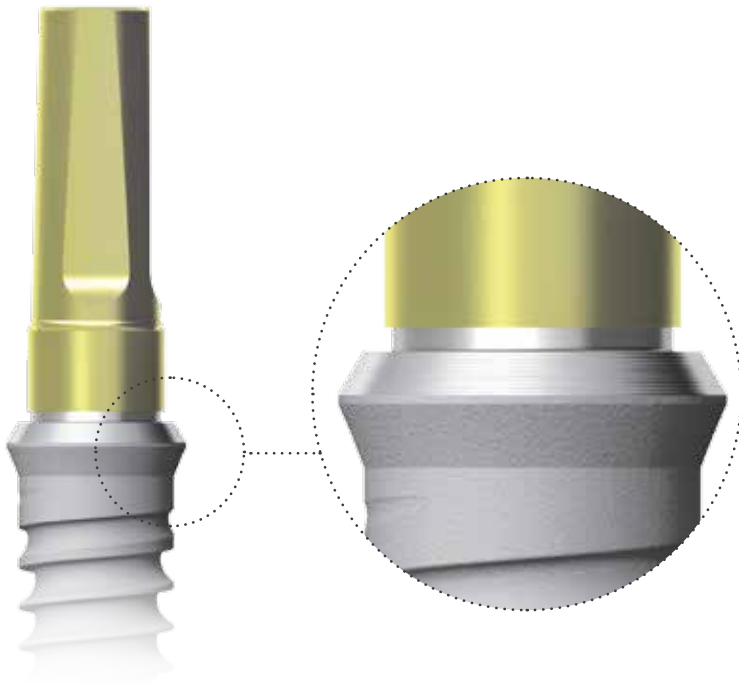

With this configuration, with a Ø 3.80 mm SP implant and a Ø 3.30 mm post, the Platform Switching can be obtained on all sides.

#### Important warning

Considering the reduced diameter of Ø 3.30 mm prosthetic components, it is recommended to use them to obtain Platform Switching with 3.80 mm implants exclusively for single crown in front sectors (excluding premolars), while in distal sectors they must be used exclusively as a support for multiple prostheses.

# Premium TG

The implants of the Premium TG system have two connection platforms:

- the “M” (Medium) connection, which has a platform with external diameter 4.80 mm, common to Premium TG implants with diameters of 3.30, 3.80 and 4.25 mm
- the “W” (Wide) connection, which has an external diameter of 5.80 mm and is only present in implants with a diameter of 5.00 mm

The M or W version is also present in the product codes of the prosthetic components, making it easy to identify the pieces to be used for reconstruction.

## “M” CONNECTION



### 20° Conical seal

This part of the connection makes use of the conical friction concept in direct screw-retained solutions. The friction works against unscrewing, and also acts as an anti-bacterial seal.

### Coupling plate

The W emergence is wide. This makes them more stable and, thanks to the coupling plate, more resistant to chewing loads coming from the molar and premolar sectors.

### Supporting shoulder

The supporting shoulder of the implant-prosthetic connection is formed by a wide external bevel with a 30° taper which contains the connection.

### Internal collar

As for submerged Premium implants, it is the anchoring point for the insert drivers.

### Internal hexagon for repositioning of the prosthesis

The hexagons of Premium TG implants have the same dimensions as the submerged Premium implants.

## “W” CONNECTION

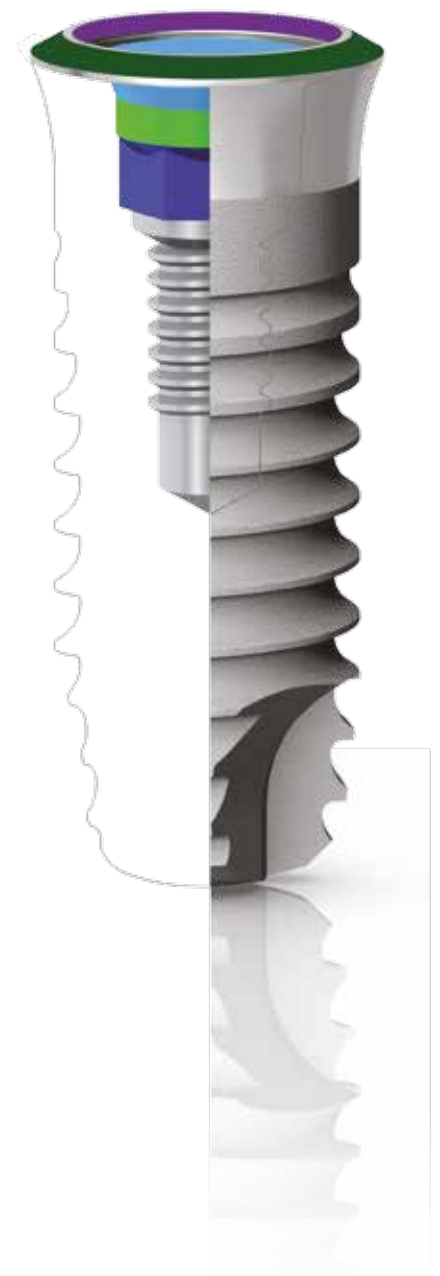

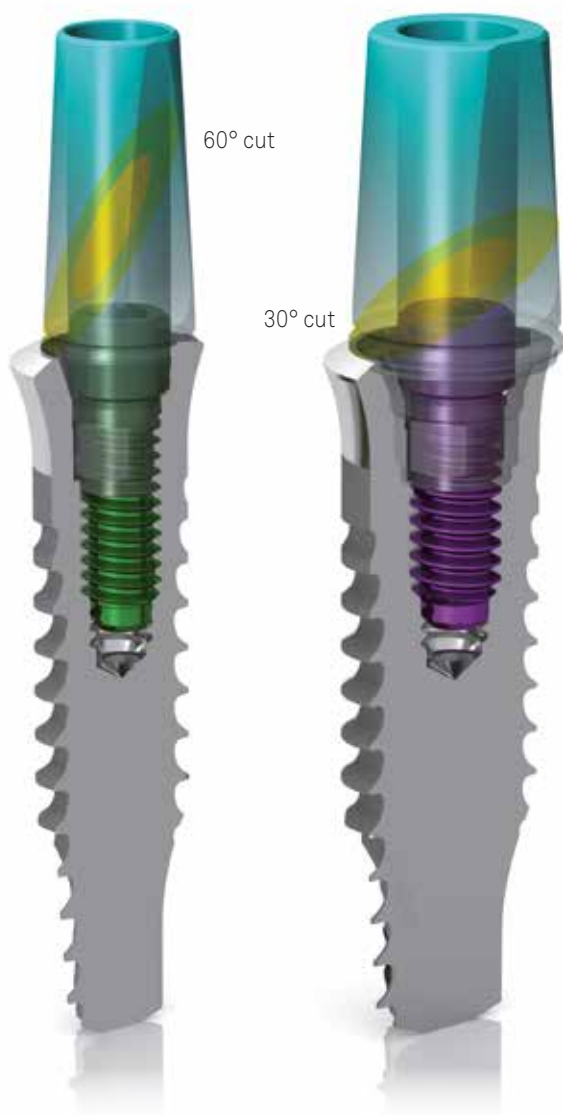

**Repositionable posts and abutments with fixation screw**

The hexagon positioned at the base of the connection cone allows using repositionable solutions, which are fixed to the implants with the aid of a fixation screw.

The fixation screw of the posts descends into the inside of the connection, thus minimising the lever fulcrum during the application of the loads and preventing the loosening of the fixation screws.







































































































**Solid posts and abutments**

The presence of a coupling cone allows the use of pre-made prosthetic components with a single body: these solutions are screwed to the prosthetic platforms without the need for separate screws. They are not repositionable, and cannot be removed once screwed into the site.

Protection caps and practical closed-tray caps are available for abutments and posts which allow the impression to be taken in the mouth on the post screwed onto the implant.

COMPLETE RANGE OF PREMIUM IMPLANTS

implant morphology	Premium Straight			
implant Ø	3.30 Straight	3.80 Straight	4.25 Straight	5.00 Straight
reference colour code on surgical tray				
colour code (on pack)				
connection platform Ø collar external Ø				
main dimensions				
connection driver hexagon colour code				
Easy Insert				
	Hexagon: 2.30 mm	Hexagon: 2.30 mm	Hexagon: 2.50 mm	Hexagon: 2.50 mm
standard final drill				
	Ø 2.80 mm	Ø 3.00 mm	Ø 3.40 mm	Ø 4.25 mm
fixation screw (thread and colour)				
	M 1.8	M 1.8	M 2.0	M 2.0
transfer colour code				
analog colour code				

Premium SP			Premium TG				implant morphology
3.80 SP	4.25 SP	5.00 SP	3.30 TG	3.80 TG	4.25 TG	5.00 TG	implant Ø
							reference colour code on surgical tray
							colour code (on pack)
<p>Ø 4.45</p> <p>Ø 3.80</p> <p>Ø 3.20</p> 	<p>Ø 4.85</p> <p>Ø 4.25</p> <p>Ø 3.60</p> 	<p>Ø 5.60</p> <p>Ø 5.00</p> <p>Ø 3.90</p> 	<p>Ø 4.80</p> <p>Ø 3.30</p> 	<p>Ø 4.80</p> <p>Ø 3.80</p> 	<p>Ø 4.80</p> <p>Ø 4.25</p> 	<p>Ø 5.80</p> <p>Ø 5.00</p> 	<p>maximum emergence Ø</p> <p>connection platform Ø</p> <p>collar external Ø</p> <p>main dimensions</p>
							connection driver hexagon colour code
 Hexagon: 2.30 mm	 Hexagon: 2.50 mm	 Hexagon: 2.50 mm	 Hexagon: 2.30 mm	 Hexagon: 2.30 mm	 Hexagon: 2.30 mm	 Hexagon: 2.50 mm	Easy Insert
 Ø 3.00 mm	 Ø 3.40 mm	 Ø 4.25 mm	 Ø 2.80 mm	 Ø 3.00 mm	 Ø 3.40 mm	 Ø 4.25 mm	standard final drill
 M 1.8	 M 2.0	 M 2.0	 M 1.8	 M 1.8	 M 1.8	 M 2.0	fixation screw (thread and colour)
							transfer colour code
							analog colour code

# Mountless surgical procedure

The implant does not require a mounter for inserting into the implant site because it is engaged directly inside the connection by practical Easy Insert drivers designed to guarantee a safe grip.

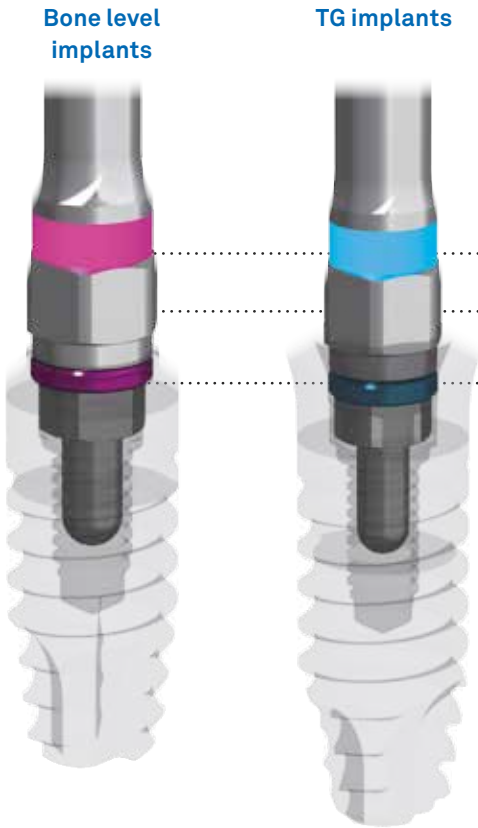

The colour code on the instrument shank and on the retaining metal O-rings facilitates the identification and choice of the item needed.

The Easy Insert drivers aid visibility of the operating field, do not occupy much space, and allow adjusting the connection hexagon properly because their hexagonal visual index is the same as a prosthetic index.

Engagement is extremely safe and reliable with the use of a special titanium O-ring that engages inside the connection.

Easy Insert drivers are available with two different hexagons, characterised by the colours blue and magenta, to be used according to the implant connection.

	Ø 3.30 mm	Ø 3.80 mm	Ø 4.25 mm	Ø 5.00 mm
Premium Straight	●	●	●	●
Premium SP	●	●	●	●
Premium TG	●	●	●	●

Blue drivers are used for implants with diameter Ø 3.30 mm and Ø 3.80 mm while magenta drivers are used for larger diameters (Ø 4.25 and Ø 5.00 mm), except the TG version Ø 4.25 mm which uses the blue driver.

**Key to the implant codes**

The implant codes are so-called “mnemonic” codes, i.e. they allow easy identification of the piece.  
 Below is a table showing how the mnemonic codes work using code A-ZT-425TG-115 as an example:

Type of implant	Surface	Diameter	Emergence	Length
A-	ZT-	425	TG-	115
A: Premium Implant	ZT: ZirTi Surface	330: 3.30 mm 380: 3.80 mm 425: 4.25 mm 500: 5.00 mm  it's the size of the platform of the implant connection	TG: Transgingival SP: Platform Switching  if no specifications are available, it refers to a standard STRAIGHT connection	060: 6.00 mm 070: 7.00 mm 085: 8.50 mm 100: 10.00 mm 115: 11.50 mm 130: 13.00 mm 150: 15.00 mm 180: 18.00 mm  refers to the length of the implant







# The surgical and prosthetic kits

The implant does not require a mounter for inserting into the implant site because it is engaged directly inside the connection by practical Easy Insert drivers designed to guarantee a safe grip.

In a single surgical and prosthetic kit all the instruments are included for the entire Premium range, including Straight, SP and TG implants.

## PREMIUM SURGICAL KIT



## SHORTY DRILLING KIT



Kit with the indispensable instruments for the short implants surgical necessities.

This kit includes just the surgical instruments for the implant insertion phase.

## ONEBOX KIT



## SCREW KIT



The Screw kit is a small set which includes the instruments necessary for the prosthetic phases.

# Surgical kit





The surgical kit for the Premium implant system have been designed for maximum simplicity and ergonomics.

The instrument codes are printed on the tray to allow the assistants to easily reposition them after cleansing and cleaning.

The standard surgical kit contains the stops for safely using the drills. These stops are extremely practical because they allow manually inserting and removing drills in tip → shank direction.



Premium surgical kit: contains all the surgical and prosthetic instruments needed for all the implants in the Premium family in all morphologies: Straight, SP and TG.

description	code
Surgical kit complete with the instruments necessary for Premium implants Straight, SP and TG	<b>ZPREMIUM-INT</b> 
Kit with 5 spare silicon supports for surgical trays, for drills or instruments with right angle shanks, not included in the kit	<b>GROMMET-3</b> 
Kit with 5 spare silicon supports for surgical trays, for hand use instruments or hand knobs, not included in the kit	<b>GROMMET-4</b> 
Kit with 5 spare silicon supports for surgical trays, for digital or manual handheld instruments, not included in the kit	<b>GROMMET-5</b> 

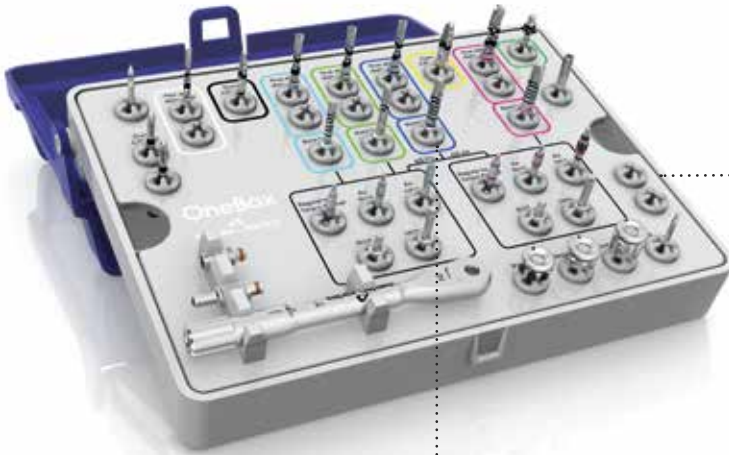

# OneBox

It is a kit equipped essentially with all that is needed only for the surgical phase. The OneBox is a compact kit that is easy to carry, containing the surgical instruments strictly necessary for inserting Premium implants in all the versions Straight, SP and TG. It does not contain drill stops or prosthetic drivers, but it contains all the drivers in the one-piece hand use version and the right angle version.



This kit contains space for an additional series of alternative drills, which the surgeon may wish to choose and use depending on his experience.

The bone taps are present in the kit in the version with right angle attachment.

description	code
OneBox surgical kit complete with the instruments for Premium implants Straight, SP and TG	<b>ZAONEBOX-INT</b> 
Kit with 5 spare silicon supports for surgical trays, for drills or instruments with right angle shanks	<b>GROMMET-CA-1</b> 
Kit with 5 spare silicon supports for surgical trays, for instruments fitted with connection hexagon	<b>GROMMET-CA-2</b> 



# Screw kit

The Sweden & Martina Screw kit is a handy set containing the drivers necessary for the prosthetic phases, from the removal of the healing abutments to the final fastening of the over-structures, the drivers for standard abutments, straight profile drivers for P.A.D. and the drivers for ball attachments.



It includes digital and right angle drivers, a carrier for angled P.A.D. abutments and a torque-control ratchet.

Small and easy to carry, it allows simple and immediate management of the prosthetic rehabilitation phase after surgery.

description	code
Screw kit complete with prosthetic instruments	<b>ZSCREW-INT</b> 
Kit with 5 spare silicon supports for surgical trays, for drills or instruments with right angle shanks	<b>GROMMET-CA-1</b> 
Kit with 5 spare silicon supports for surgical trays, for instruments fitted with connection hexagon	<b>GROMMET-CA-2</b> 

# Initial, intermediate and countersink drills

All Sweden & Martina drills are made of steel for surgical use.

**Precision drill:** very sharp and precise, it facilitates the opening of the implant site.







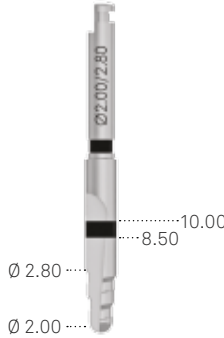
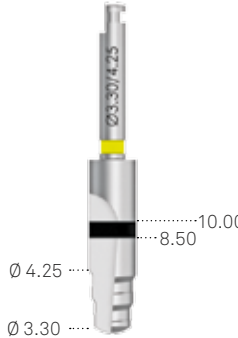
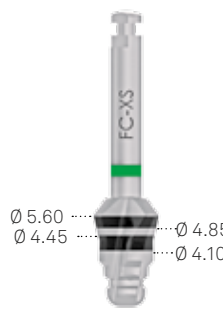

**Intermediate drills:** the shape with progressive diameter of the 2.00 intermediate drills.

**Pilot drill:** the different heights of the laser markings.

**Countersink drill:** ideal for preparing the coronal part of the site in the case of implants with Platform Switching neck.

initial drill, intermediate drills and countersink drill				kit
<p><b>FS-230</b> precision drill</p> 	<p><b>FG-200/280XS</b> intermediate drill Ø 2.00 - 2.80 mm</p> 	<p><b>FG-330/425XS</b> intermediate drill Ø 3.30 - 4.25 mm</p> 	<p><b>FC-XS</b> countersink drill</p> 	ZPREMIUM-INT ZAONEBOX-INT

pilot drill and relative stops							kit
<p><b>FPT3-200-LXS</b> pilot drill</p> 	<p><b>STOP3-200-070</b> pilot drill stop</p> 	<p><b>STOP3-200-085</b> pilot drill stop</p> 	<p><b>STOP3-200-100</b> pilot drill stop</p> 	<p><b>STOP3-200-115</b> pilot drill stop</p> 	<p><b>STOP3-200-130</b> pilot drill stop</p> 	<p><b>STOP3-200-150</b> pilot drill stop</p> 	ZPREMIUM-INT ZAONEBOX-INT

**LL:** Total length of the working part, including the tip.

**LS:** Length of the tip. This measurement must be calculated in addition to the length of the preparation hole.

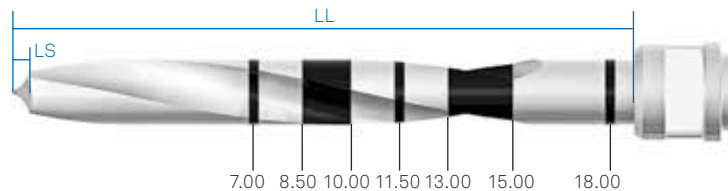











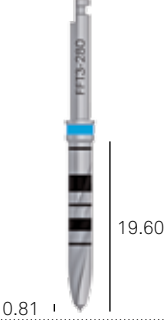
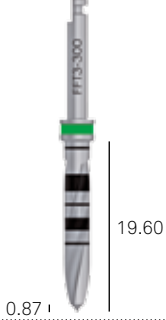
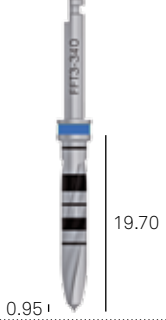











**Please note:** The initial drills in this page and the final drills in the following page always make an osteotomy longer than the implant that is to be inserted. The oversizing (LS) is equal to the height of the tip of the drill that is being used. See drawing above.

# Final drills and stops

Also made of steel for surgical use, Premium final drills present a number of cutting edges proportional to the hole diameter, so as to allow a continuous and homogeneous cutting movement and greater instrument stability during operation. All this enables high-precision implant preparations to be obtained, with consequent ease in inserting the implant.



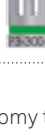
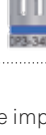
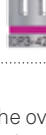

implant Ø	Ø 3.30 mm	Ø 3.80 mm	Ø 4.25 mm	Ø 5.00 mm	kit
drills	<b>FFT3-280-LXS</b> 	<b>FFT3-300-LXS</b> 	<b>FFT3-340-LXS</b> 	<b>FFT3-425-LXS</b> 	ZPREMIUM-INT ZAONEBOX-INT
stop	<b>STOP3-280-070</b> 	<b>STOP3-300-070</b> 	<b>STOP3-340-070</b> 	<b>STOP3-425-070</b> 	ZPREMIUM-INT
	<b>STOP3-280-085</b> 	<b>STOP3-300-085</b> 	<b>STOP3-340-085</b> 	<b>STOP3-425-085</b> 	ZPREMIUM-INT
	<b>STOP3-280-100</b> 	<b>STOP3-300-100</b> 	<b>STOP3-340-100</b> 	<b>STOP3-425-100</b> 	ZPREMIUM-INT
	<b>STOP3-280-115</b> 	<b>STOP3-300-115</b> 	<b>STOP3-340-115</b> 	<b>STOP3-425-115</b> 	ZPREMIUM-INT
	<b>STOP3-280-130</b> 	<b>STOP3-300-130</b> 	<b>STOP3-340-130</b> 	<b>STOP3-425-130</b> 	ZPREMIUM-INT
	<b>STOP3-280-150</b> 	<b>STOP3-300-150</b> 	<b>STOP3-340-150</b> 	<b>STOP3-425-150</b> 	ZPREMIUM-INT

**Please note:** The drills always make an osteotomy that is longer than the implant to be inserted. The oversizing (LS) is equal to the height of the tip of the drill that is being used (see drawing on page 31 for the key).

# Drills for distal sectors

As an option, drills are available that are idoneous in distal sectors with limited oral opening. They come in a wide range of diameters and are also useful for preparations in extremely compact bone where, in the most coronal portion, it is desirable to widen the preparation diameter by 0.10 mm with respect to the size of the standard drills to facilitate the insertion of the implants.

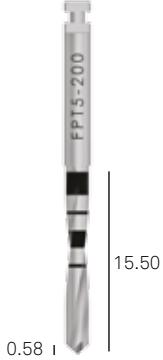
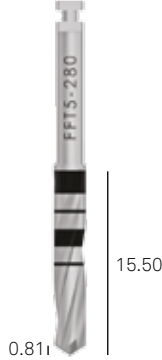
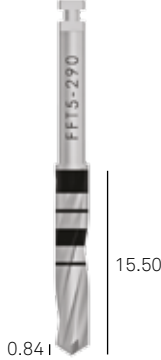
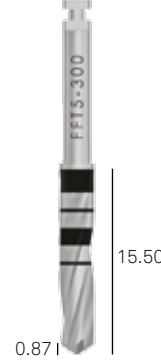
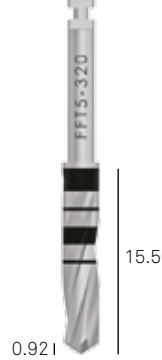

Ø 2.00 mm	Ø 2.80 mm	Ø 2.90 mm	Ø 3.00 mm	Ø 3.20 mm
<b>FPT5-200-LXS</b> cylindrical drill Ø 2.00 mm 	<b>FFT5-280-LXS</b> cylindrical drill Ø 2.80 mm 	<b>FFT5-290-LXS</b> cylindrical drill Ø 2.90 mm 	<b>FFT5-300-LXS</b> cylindrical drill Ø 3.00 mm 	<b>FFT5-320-LXS</b> cylindrical drill Ø 3.20 mm 

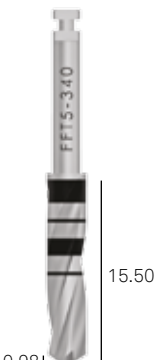
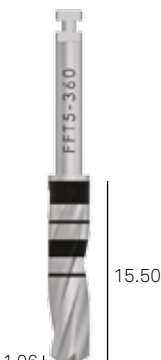
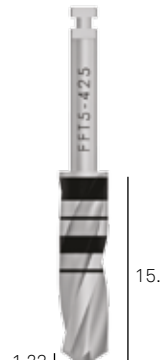
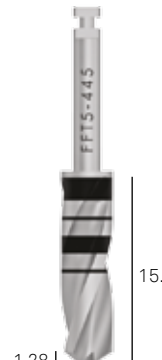
Ø 3.30 mm	Ø 3.40 mm	Ø 3.60 mm	Ø 4.25 mm	Ø 4.45 mm
<b>FFT5-330-LXS</b> cylindrical drill Ø 3.30 mm 	<b>FFT5-340-LXS</b> cylindrical drill Ø 3.40 mm 	<b>FFT5-360-LXS</b> cylindrical drill Ø 3.60 mm 	<b>FFT5-425-LXS</b> cylindrical drill Ø 4.25 mm 	<b>FFT5-445-LXS</b> cylindrical drill Ø 4.45 mm 

The drills for distal sectors are without irrigation and are not included in any surgical kit. They cannot be used with depth stops.

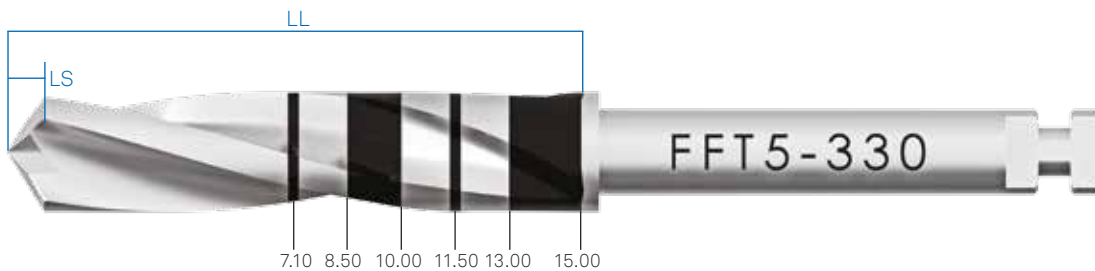

**Please note:** The drills always make an osteotomy that is longer than the implant to be inserted. The oversizing (LS) is equal to the height of the tip of the drill that is being used. See drawing above.

# Osteotomes

A set of osteotomes made of steel for surgical use is available, useful for maxillary sinus floor expansion and lift protocols via the crestal bone.

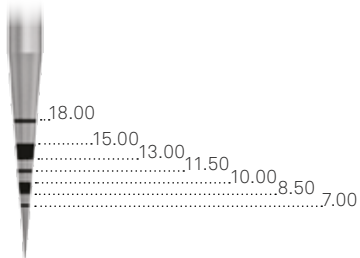
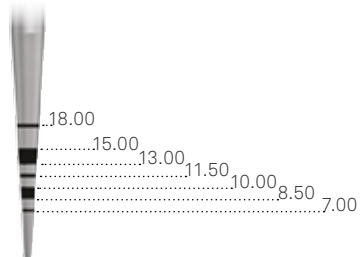
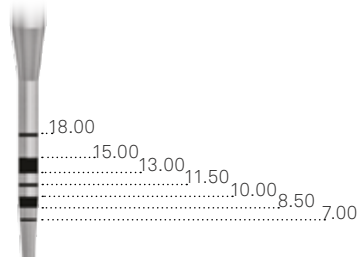
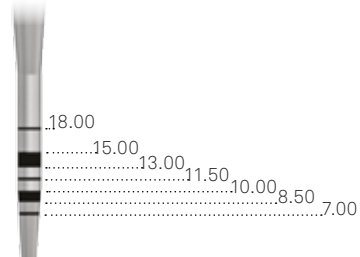
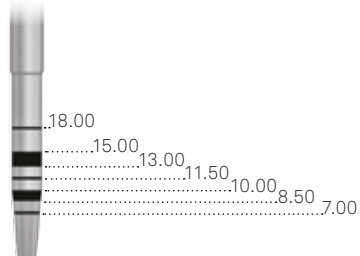
description	code
Osteotome Ø 0.20, flat tip	<b>E-OS-020-PP</b> 
Osteotome Ø 0.90, flat tip	<b>E-OS-090-PP</b> 
Osteotome Ø 1.60, concave tip	<b>E-OS-160-PC</b> 
Osteotome Ø 2.00, concave tip	<b>E-OS-200-PC</b> 
Osteotome Ø 2.40, concave tip	<b>E-OS-240-PC</b> 

The osteotomes are not included in any kit. They are to be ordered separately.

# Bone taps

**Bone tap with hexagonal attachment:** for use with the torque-control ratchet.

**Bone tap with right angle attachment:** for use with the hand piece of the micromotor.

**Short bone tap:** for use with the torque-control ratchet, for distal sectors.



implant Ø	Ø 3.30 mm	Ø 3.80 mm	Ø 4.25 mm	Ø 5.00 mm	kit
bone taps with hexagonal attachment	<b>A-MS-330</b> 	<b>A-MS-380</b> 	<b>A-MS-425</b> 	<b>A-MS-500</b> 	ZPREMIUM-INT
bone taps with right angle attachment	<b>A-MS-330-CA</b> 	<b>A-MS-380-CA</b> 	<b>A-MS-425-CA</b> 	<b>A-MS-500-CA</b> 	ZAONEBOX-INT
short bone taps	<b>A-MSC-330</b> 	<b>A-MSC-380</b> 	<b>A-MSC-425</b> 	<b>A-MSC-500</b> 	-







All measurements are given in mm, unless indicated otherwise.

# Additional instruments





All the additional instruments for inserting Premium implants Straight, SP and TG, made of steel for surgical use, have been designed to offer maximum ergonomics and ease of use. All the instruments have a laser-marked code for easy identification.



## Carriers and drivers for implants



description	code	kit
Short driver, with right angle shank, for Premium implants Ø 3.30 and Ø 3.80 mm	<b>EASYC2-EX230-CA</b> 	ZPREMIUM-INT ZAONEBOX-INT
Long driver, with right angle shank, for Premium implants Ø 3.30 and Ø 3.80 mm	<b>EASYL2-EX230-CA</b> 	ZPREMIUM-INT ZAONEBOX-INT
Short driver with connector for torque-control ratchet, for Premium implants Ø 3.30 and Ø 3.80 mm	<b>EASY2-EX230-EX</b> 	ZPREMIUM-INT ZAONEBOX-INT
Short driver, with right angle shank, for Premium implants Ø 4.25 and Ø 5.00 mm	<b>EASYC2-EX250-CA</b> 	ZPREMIUM-INT ZAONEBOX-INT
Long driver, with right angle shank, for Premium implants Ø 4.25 and Ø 5.00 mm	<b>EASYL2-EX250-CA</b> 	ZPREMIUM-INT ZAONEBOX-INT
Short driver with connector for torque-control ratchet, for Premium implants Ø 4.25 and Ø 5.00 mm	<b>EASY2-EX250-EX</b> 	ZPREMIUM-INT ZAONEBOX-INT

## Drivers



description	code	kit
Short driver (hex 2.30)	<b>BC-EX230</b> 	ZPREMIUM-INT ZAONEBOX-INT
Long driver (hex 2.30)	<b>BL-EX230</b> 	ZPREMIUM-INT ZAONEBOX-INT
Short driver (hex 2.50)	<b>BC-EX250</b> 	ZPREMIUM-INT ZAONEBOX-INT
Long driver (hex 2.50)	<b>BL-EX250</b> 	ZPREMIUM-INT ZAONEBOX-INT

All measurements are given in mm, unless indicated otherwise.

### Surgical screwdrivers

description	code	kit
Screwdriver for surgical cover screw and fixation screws, digital, extra-short	<b>HSMXS-20-DG</b> 	ZAONEBOX-INT ZSCREW-INT
Screwdriver for surgical cover screw and fixation screws, digital, short	<b>HSM-20-DG</b> 	ZPREMIUM-INT ZAONEBOX-INT ZSCREW-INT
Screwdriver for surgical cover screw and fixation screws, digital, long	<b>HSML-20-DG</b> 	ZPREMIUM-INT ZAONEBOX-INT ZSCREW-INT

### Mounters

description	code	kit
Mounter, for implants: - Ø 3.30 and Ø 3.80 mm Premium Straight and SP - Ø 3.30, Ø 3.80 and Ø 4.25 mm Premium TG	<b>MOU-EX230</b> 	ZPREMIUM-INT ZAONEBOX-INT
Mounter, for implants: - Ø 4.25 and 5.00 mm Premium Straight and SP - Ø 5.00 mm Premium TG	<b>MOU-EX250</b> 	ZPREMIUM-INT ZAONEBOX-INT

### Torque-control ratchet

description	code	kit
Kit composed of a torque control ratchet, which can be used in dynamometric or fixed mode, and accessories for quick torque adjustment and periodic maintenance. The ratchet has torque limits from 10 to 70 Ncm, with adjustment lines at 10-20-25-30-35-50-70 Ncm	<b>CRI5-KIT</b> 	ZPREMIUM-INT ZONEBOX-INT ZSCREW-INT ZPA001E01



### Depth gauge

description	code	kit
Depth gauge	<b>PROF3</b> 	ZPREMIUM-INT









### Mounter key stop

description	code	kit
Mounter stop key	<b>CM2</b> 	ZPREMIUM-INT ZAONEBOX-INT







### Parallelism pin

description	code	kit
Parallelism pins with one side $\varnothing$ 2.00 and the other $\varnothing$ 2.80 mm	<b>PP-2/28</b> 	ZPREMIUM-INT ZAONEBOX-INT

**Prosthetic screwdrivers**

description	code	kit
Screwdriver for fixation screws, with hexagonal connector for torque-control ratchet or hand knob, short	<b>HSM-20-EX</b> 	ZPREMIUM-INT ZAONEBOX-INT ZSCREW-INT
Screwdriver for fixation screws, with hexagonal connector for torque-control ratchet or hand knob, long	<b>HSML-20-EX</b> 	ZPREMIUM-INT ZAONEBOX-INT ZSCREW-INT ZPA001E01
Screwdriver for fixation screws, with hexagonal connector for torque-control ratchet or hand knob, extra-long	<b>HSMXL-20-EX</b> 	ZPREMIUM-INT ZAONEBOX-INT ZSCREW-INT
Screwdriver for fixation screws, with right angle shank	<b>HSM-20-CA</b> 	ZPREMIUM-INT ZAONEBOX-INT ZSCREW-INT
Screwdriver for ball attachments, with hexagonal connector for torque-control ratchet	<b>BASCC-EX</b> 	ZSCREW-INT
Screwdriver for for straight P.A.D. abutments, with hexagonal connector for torque-control ratchet	<b>AVV2-ABUT</b> 	ZSCREW-INT
Driver for inserting Locator abutment, with hexagonal connector for torque-control ratchet, short	<b>8926-SW</b> 	ZSCREW-INT
Driver for inserting Locator abutment, with hexagonal connector for torque-control ratchet, long	<b>8927-SW</b> 	ZSCREW-INT
Instrument for assembly and maintaining the titanium cap for CAP-TIT-1 ball attachments	<b>AVV-CAP-TIT-1</b> 	ZSCREW-INT

## Extensions and adapters

description	code	kit
Extension for bone taps, mounters, drivers and manual drivers, with hexagonal connector for torque-control ratchet	<b>BPM-15</b> 	ZPREMIUM-INT ZAONEBOX-INT
Extension for surgical drills	<b>PROF-CAL3</b> 	ZPREMIUM-INT ZAONEBOX-INT
Mechanical adapter with right angle shank for instruments with hexagonal connector	<b>B-AVV-CA3</b> 	ZPREMIUM-INT ZAONEBOX-INT ZSCREW-INT
Hand knob for instruments with hexagonal connection for torque-control ratchet	<b>AVV3-MAN-DG</b> 	ZPREMIUM-INT ZAONEBOX-INT ZSCREW-INT ZPA001E01
Knob for manual use of drivers, bone taps and drivers with contra-angle shank and with hexagonal connection for torque-control ratchet	<b>AVV-CA-DG-EX</b> 	ZAONEBOX-INT
Carrier for transferring angled abutments into the oral cavity, sterilisable and reusable. It must be secured to the abutments with the screw PAD-VTRAL-140	<b>PAD-CAR</b> 	ZSCREW-INT



## Prosthetic accessories kit

description	code
<p>The Prosthetic Accessories Kit includes the torque-control ratchet, the long digital screwdriver with the connection for torque-control ratchet and the related hand knob. This kit is very useful for the prosthetic rehabilitation phase</p>	<b>ZPA001E01</b> 

Spare O-rings

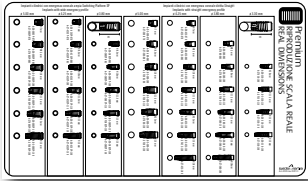

description	code	kit
Kit with 5 spare O-rings for all accessories with hexagonal connector for torque-control ratchet	ORING180-088  	-

X-ray templates

description	code	kit
X-ray template for Premium Straight and SP implants, real dimensions, dimensions increased by 20% and dimensions increased by 30%	A-L100 A-L120 A-L130  	ZPREMIUM-INT ZAONEBOX-INT
X-ray template for Premium TG implants, real dimensions, dimensions increased by 20% and dimensions increased by 30%	A-TG-L100 A-TG-L120 A-TG-L130  	ZPREMIUM-INT ZAONEBOX-INT

# Bone profilers



Implant	Ø 3.30 mm	Ø 3.80 mm	Ø 4.25 mm	Ø 5.00 mm
Bone profiler with narrow flaring	A-PAD-PS330-S 	A-PAD-PS380-S 	A-PAD-PS425-S 	A-PAD-PS500-S 
Bone profiler with wide flaring	A-PAD-PS330-L 	A-PAD-PS380-L 	A-PAD-PS425-L 	A-PAD-PS500-L 

The bone profilers are not included in any kit. They are to be ordered separately.

All measurements are given in mm, unless indicated otherwise.



# Shorty Drilling kit

The Shorty drills allow dedicating the entire bone available to inserting the implant, without any over-preparation due to the tip morphology of the standard drills (for example, to insert a Premium implant of 7.00 mm using the Shorty drills, an actual hole of 7.00 mm will be made, and not 7.00 mm plus the portion of over-preparation). Moreover, the Shorty drills have the advantage, compared to traditional drills, of being shorter than the standard drills (24.85 mm instead of 35.00 mm). This important feature makes it possible to use these instruments even in case of difficult to reach distal sectors or small oral openings.



The kits contain two short parallelism pins, which are very handy in distal sectors.

The colour codes of platform guides the choice of the instruments.

description	code
Drilling kit for short implants	<b>ZSHORTY-INT</b> 
Kit with 5 spare silicon supports for surgical trays, for drills or instruments with right angle shanks	<b>GROMMET-CA-1</b> 

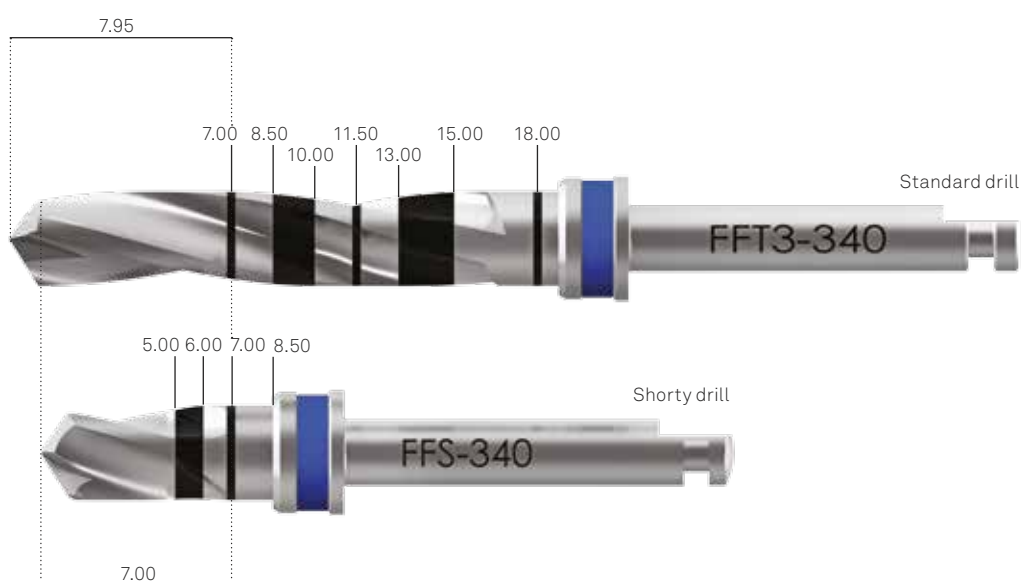









**Please note:** remember that the drills in the Shorty Drilling kit do not over-prepare the surgical site. The working lengths include the portion related to the conical tip of the drill.

**Important warning**

The Shorty Drilling kit is a kit of **only** drills, which also contains two parallelism pins. However, it is not a complete kit; to insert short implants the instruments in the standard surgical kit are required (ratchet, drivers, etc.).

Instruments contained in the Shorty Drilling kit

Shorty pilot drill	Shorty pilot drill stops		
<p><b>FPS-200</b> Shorty pilot drill</p> 	<p><b>STOPS-200-050</b> 5.00 mm stop for Shorty pilot drill</p> 	<p><b>STOPS-200-060</b> 6.00 mm stop for Shorty pilot drill</p> 	<p><b>STOPS-200-070</b> 7.00 mm stop for Shorty pilot drill</p> 

description	diameter	code	
Short guide drill	2.00/2.50/3.00	<b>FGS-200/300</b>	
Short guide drill	3.40/3.80/4.25	<b>FGS-340/425</b>	
Short guide drill	4.25/4.80/5.40	<b>FGS-425/540*</b>	
Parallelism pin for short implants, with depth lines at 5.00, 6.00 and 7.00 mm	2.00/3.00	<b>PPS-2/3</b>	



connection	Ø 3.80 mm	Ø 4.25 mm	Ø 5.00 mm	Ø 6.00 mm
drill	<b>FFS-300</b>  24.85	<b>FFS-340</b>  24.85	<b>FFS-425</b>  24.85	<b>FFS-540*</b>  24.85
stop	<b>STOPS-300-050</b> 	<b>STOPS-340-050</b> 	<b>STOPS-425-050</b> 	<b>STOPS-540-050*</b> 
	<b>STOPS-300-060</b> 	<b>STOPS-340-060</b> 	<b>STOPS-425-060</b> 	<b>STOPS-540-060*</b> 
	<b>STOPS-300-070</b> 	<b>STOPS-340-070</b> 	<b>STOPS-425-070</b> 	<b>STOPS-540-070*</b> 

\* Drills and stops with diameter 4.25 mm for other Sweden & Martina implant systems are available in the Shorty Drilling kit.

All measurements are given in mm, unless indicated otherwise.



# Premium Straight and SP prosthetic components

# Healing abutments

The healing abutments, in Gr. 5 titanium, can be identified by a laser marking that reports the diameter, emergence profile and height. In case of healing abutments with straight emergence profile, the marking only reports the platform diameter and height.

The healing abutments caps must be tightened at a torque of 8-10 Ncm, using the HSM series of drivers, the full details and codes of which can be found on page 42.

## Healing abutments with straight emergence profile:

the laser marking, on the side, allows immediate recognition of the connection diameter (38 = 3.80 mm) and of the transgingival height (3 = 3 mm).



**Guiding cylinder:** facilitates centring when inserting the into the implant.

## Healing abutments with anatomical emergence profile:

the laser marking, on the upper surface, shows the connection diameter (50 = 5.00 mm), the maximum crown size (60 = 6.00 mm) and the transgingival height (2 = 2.00 mm).

connection	Ø 3.30 mm	Ø 3.80 mm	Ø 4.25 mm	Ø 5.00 mm
Healing abutments Anatomical emergence profile Transgingival height 2.00 mm	<b>A-TMGR-330-2</b>  Ø 3.30..... 2.00 M 1.8.....	<b>A-TMGR-380-2</b>  Ø 3.80..... 2.00 M 1.8.....	<b>A-TMGR-425-2</b>  Ø 4.25..... 2.00 M 2.0.....	<b>A-TMGR-500-2</b>  Ø 5.00..... 2.00 M 2.0.....
Healing abutments Anatomical emergence profile Transgingival height 3.00 mm	<b>A-TMGR-330-3</b>  Ø 3.30..... 3.00 M 1.8.....	<b>A-TMGR-380-3</b>  Ø 3.80..... 3.00 M 1.8.....	<b>A-TMGR-425-3</b>  Ø 4.25..... 3.00 M 2.0.....	<b>A-TMGR-500-3</b>  Ø 5.00..... 3.00 M 2.0.....
Healing abutments Anatomical emergence profile Transgingival height 5.00 mm	<b>A-TMGR-330-5</b>  Ø 3.30..... 5.00 M 1.8.....	<b>A-TMGR-380-5</b>  Ø 3.80..... 5.00 M 1.8.....	<b>A-TMGR-425-5</b>  Ø 4.25..... 5.00 M 2.0.....	<b>A-TMGR-500-5</b>  Ø 5.00..... 5.00 M 2.0.....
Healing abutments Anatomical emergence profile Transgingival height 7.00 mm	-	<b>A-TMGR-380-7</b>  Ø 3.80..... 7.00 M 1.8.....	<b>A-TMGR-425-7</b>  Ø 4.25..... 7.00 M 2.0.....	<b>A-TMGR-500-7</b>  Ø 5.00..... 7.00 M 2.0.....
Healing abutments Straight emergence profile Transgingival height 2.00 mm	<b>A-TMG-330-2</b>  Ø 3.30..... 33/2 2.00 M 1.8.....	<b>A-TMG-380-2</b>  Ø 3.80..... 38/2 2.00 M 1.8.....	-	-
Healing abutments Straight emergence profile Transgingival height 3.00 mm	<b>A-TMG-330-3</b>  Ø 3.30..... 33/3 3.00 M 1.8.....	<b>A-TMG-380-3</b>  Ø 3.80..... 38/3 3.00 M 1.8.....	-	-
Healing abutments Straight emergence profile Transgingival height 5.00 mm	<b>A-TMG-330-5</b>  Ø 3.30..... 33/5 5.00 M 1.8.....	<b>A-TMG-380-5</b>  Ø 3.80..... 38/5 5.00 M 1.8.....	-	-

Recommended torque for healing abutments: 8-10 Ncm.

All measurements are given in mm, unless indicated otherwise.

# Impression and model phase

The open tray and closed tray transfers are made of Gr. 5 titanium, anodised according to the colour code of the reference platform, facilitating the identification of any different diameters that may be used.

The pull-up transfer is made of radiopaque PEEK to allow checking of the correct insertion in the implant platform.

**Open tray transfer:** the retentive design guarantees a steady grip in the upper portion of the impression.

**Closed tray transfer:** ideal for taking impressions with the closed tray technique, the repositioning face allows the transfer to be put back exactly in the impression material so as to reproduce the orientation of the connection precisely.

**Implant analog:** anodised according to the colour code to identify the different prosthetic platforms.



**Pull-up transfer:** the connection with tabs clicks into the implant connecting hexagon, without requiring a screw.

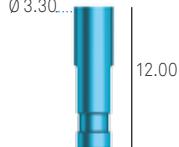
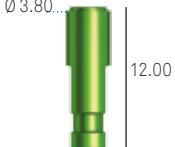
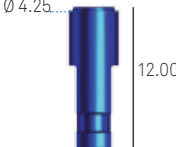
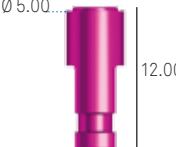

**Analogs**

connection	Ø 3.30 mm	Ø 3.80 mm	Ø 4.25 mm	Ø 5.00 mm
Analogs	<b>A-ANA-330</b> 	<b>A-ANA-380</b> 	<b>A-ANA-425</b> 	<b>A-ANA-500</b> 

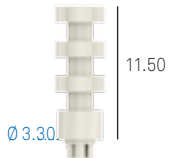
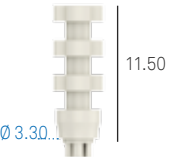
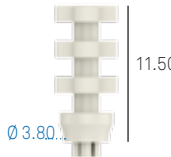
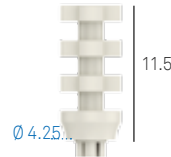
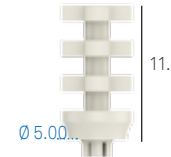
**Pull-up transfers**

connection	Ø 3.30 mm	Ø 3.80 mm	Ø 4.25 mm	Ø 5.00 mm
Pull-up transfers in radiopaque PEEK Straight emergence profile	<b>A-TRAP-330</b> 	-	-	-
Pull-up transfers in radiopaque PEEK Anatomical emergence profile	<b>A-TRARP-330</b> 	<b>A-TRARP-380</b> 	<b>A-TRARP-425</b> 	<b>A-TRARP-500</b> 

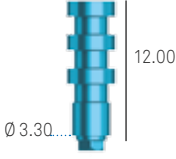
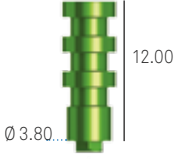
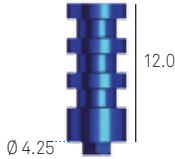
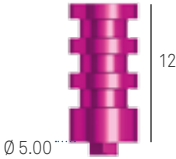
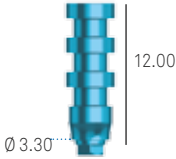
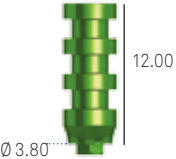
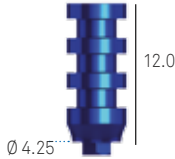
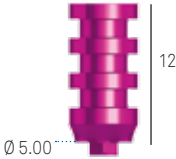
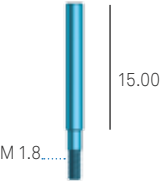

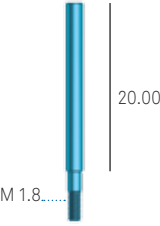
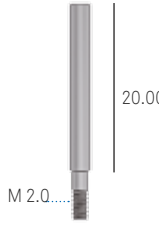
Open tray transfers

connection	Ø 3.30 mm	Ø 3.80 mm	Ø 4.25 mm	Ø 5.00 mm
Open tray transfers Straight emergence profile Fixation screw included	<b>A-TRA-330</b> 	<b>A-TRA-380</b> 	- 	- 
Open tray transfers Anatomical emergence profile Fixation screw included	<b>A-TRAR-330</b> 	<b>A-TRAR-380</b> 	<b>A-TRAR-425</b> 	<b>A-TRAR-500</b> 
Single pack Fixation screws for open tray transfers Supplied with the transfers, it can also be ordered separately as a spare	<b>VTRA2-180-15</b> 	Use VTRA2-180-15	<b>VTRA2-200-15</b> 	Use VTRA2-200-15
Single pack Fixation screws for open tray transfer, length 20.00, can be ordered as a spare	<b>VTRA2-180-20</b> 	Use VTRA2-180-20	<b>VTRA2-200-20</b> 	Use VTRA2-200-20

Recommended torque for transfer screws: 8-10 Ncm.

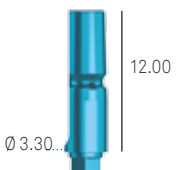

Closed tray transfers

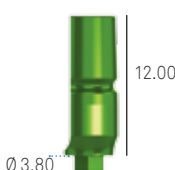
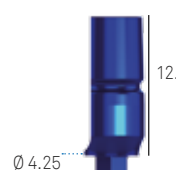
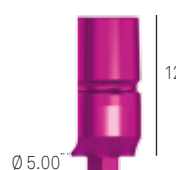
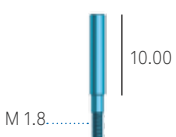
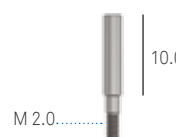
connection	Ø 3.30 mm	Ø 3.80 mm	Ø 4.25 mm	Ø 5.00 mm
Closed tray transfers Straight emergence profile Fixation screw included	<b>A-TRAS-330</b>  Ø 3.30 12.00	-	-	-
Closed tray transfers Anatomical emergence profile Fixation screw included	<b>A-TRARS-330</b>  Ø 3.30 12.00	<b>A-TRARS-380</b>  Ø 3.80 12.00	<b>A-TRARS-425</b>  Ø 4.25 12.00	<b>A-TRARS-500</b>  Ø 5.00 12.00
Single pack Fixation screws for open tray transfers Supplied with the transfers, it can also be ordered separately as a spare	<b>VTRA2-180-10</b>  M 1.8 10.00	Use VTRA2-180-10	<b>VTRA2-200-10</b>  M 2.0 10.00	Use VTRA2-200-10

Recommended torque for transfer screws: 8-10 Ncm.

All measurements are given in mm, unless indicated otherwise.

# SIMPLE temporary posts

The SIMPLE prosthetic protocol calls for creating the temporary posts. They are made in Gr. 5 titanium or in PEEK with titanium base, and are available in repositionable and non-repositionable version.



**PEEK** post with titanium base for cement-retained single crowns.



**Aesthetic temporary post** with the widest flaring of the transgingival profile, adaptable to any anatomy by drilling, for aesthetic conditioning of the mucosa.

**Temporary posts without repositioning hexagon** and with narrow transgingival profile for multiple temporary structures to be screwed directly onto the implants.

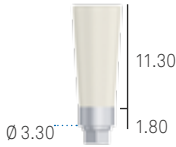
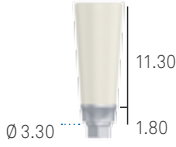
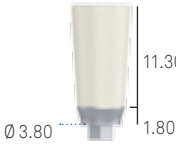
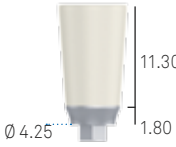
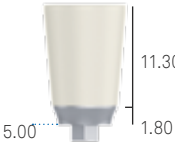
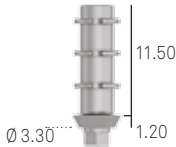
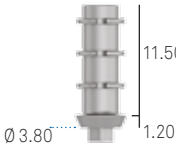
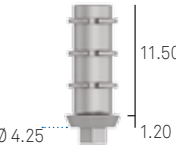
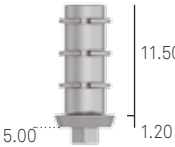
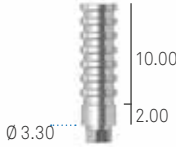
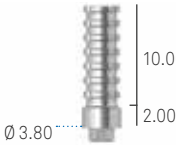
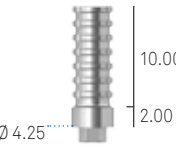
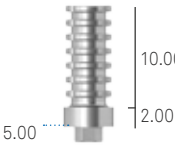
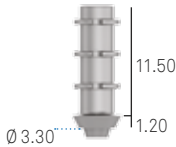
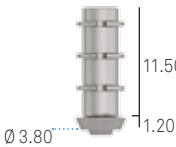
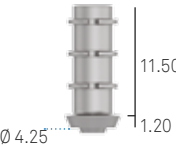
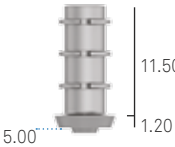
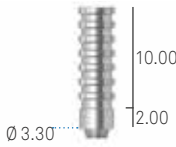
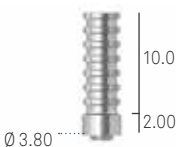
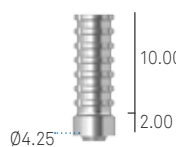
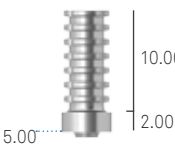
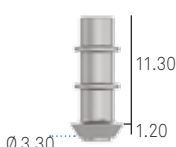
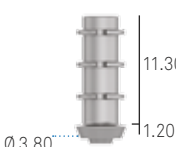
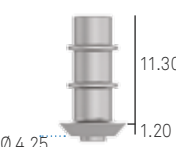
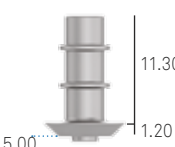
**Temporary post with hexagon** for making single screwed temporary posts.

connection	Ø 3.30 mm	Ø 3.80 mm	Ø 4.25 mm	Ø 5.00 mm
SIMPLE temporary posts in PEEK with a Gr. 5 titanium base Repositionable Straight emergence profile Fixation screw included	<b>A-MPSC-330</b> 	-	-	-
SIMPLE temporary posts in PEEK with a Gr. 5 titanium base Repositionable Anatomical emergence profile Fixation screw included	<b>A-MPSCR-330</b> 	<b>A-MPSCR-380</b> 	<b>A-MPSCR-425</b> 	<b>A-MPSCR-500</b> 
SIMPLE temporary posts in Gr. 5 titanium Repositionable Anatomical emergence Fixation screw included	<b>A-MPSA-330-EX</b> 	<b>A-MPSA-380-EX</b> 	<b>A-MPSA-425-EX</b> 	<b>A-MPSA-500-EX</b> 
SIMPLE temporary posts in Gr. 5 titanium Repositionable Straight emergence profile	<b>A-MPSCI-330-EX</b> 	<b>A-MPSCI-380-EX</b> 	<b>A-MPSCI-425-EX</b> 	<b>A-MPSCI-500-EX</b> 
SIMPLE temporary posts in Gr. 5 titanium Non-repositionable Anatomical emergence profile Fixation screw included	<b>A-MPSA-330</b> 	<b>A-MPSA-380</b> 	<b>A-MPSA-425</b> 	<b>A-MPSA-500</b> 
SIMPLE temporary posts in Gr. 5 titanium Non-repositionable Straight emergence profile	<b>A-MPSCI-330</b> 	<b>A-MPSCI-380</b> 	<b>A-MPSCI-425</b> 	<b>A-MPSCI-500</b> 
SIMPLE temporary aesthetic posts in Gr. 5 titanium Non-repositionable Wide emergence profile Fixation screw included	<b>A-MPS-330</b> 	<b>A-MPS-380</b> 	<b>A-MPS-425</b> 	<b>A-MPS-500</b> 
Single pack Pack of 10 pieces	<b>VM2-180</b> <b>VM2-180-10</b>	Use VM2-180	<b>VM2-200</b> <b>VM2-200-10</b>	Use VM2-200
Fixation screw for posts Supplied with the temporary posts, it can also be ordered separately as a spare	M 1.8 		M 2.0 	

Recommended torque for fixation screws: 20-25 Ncm.

All measurements are given in mm, unless indicated otherwise.

# Pre-made posts

Made of Gr. 5 titanium, their colour is obtained through an oxidation process and, therefore, there is no type of coating, so it ensures the use of a highly biocompatible surface.

**Angled posts:** with a fixation screw they offer 15° or 25° angles;

**Colour:** Their colour is suitable for prosthetic rehabilitations of particular aesthetic importance.



**Solid one-piece abutments:** they are useful for cementing multiple prostheses on parallel implants.

**Hexagon:** allows repositioning and the non-rotational aspect; this type of post is therefore indicated for making single structures.

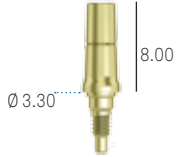
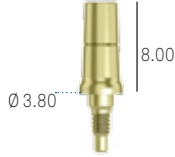
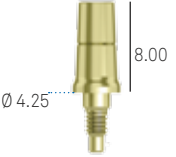
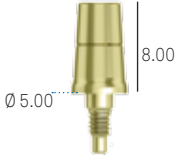
connection	Ø 3.30 mm	Ø 3.80 mm	Ø 4.25 mm	Ø 5.00 mm
Solid one-piece abutments Non-repositionable	<b>A-MDAD-330</b> 	<b>A-MDAD-380</b> 	<b>A-MDAD-425</b> 	<b>A-MDAD-500</b> 

Recommended torque: 25-30 Ncm.

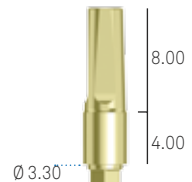

connection	Ø 3.30 mm	Ø 3.80 mm	Ø 4.25 mm	Ø 5.00 mm
Pre-made straight posts Repositionable Straight emergence profile Transgingival height 1.00 mm Fixation screw included	<b>A-MD-330-1</b> 	<b>A-MD-380-1</b> 	-	-
Pre-made straight posts Repositionable Straight emergence profile Transgingival height 2.00 mm Fixation screw included	<b>A-MD-330-2</b> 	<b>A-MD-380-2</b> 	-	-
Pre-made straight posts Repositionable Straight emergence profile Transgingival height 4.00 mm Fixation screw included	<b>A-MD-330-4</b> 	<b>A-MD-380-4</b> 	-	-
Single pack Pack of 10 pieces  Fixation screw Supplied with the posts, it can also be ordered separately as a spare	<b>VM2-180</b> <b>VM2-180-10</b> 	Use VM2-180	-	-

Recommended torque for fixation screws: 20-25 Ncm.

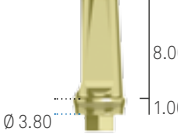
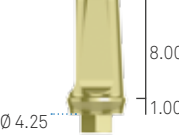
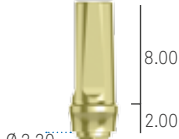
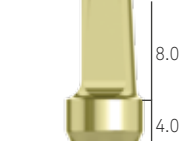
All measurements are given in mm, unless indicated otherwise.

connection	Ø 3.30 mm	Ø 3.80 mm	Ø 4.25 mm	Ø 5.00 mm
Pre-made straight posts Repositionable Anatomical emergence profile Transgingival height 1.00 mm Fixation screw included	<b>A-MDR-330-1</b> 	<b>A-MDR-380-1</b> 	<b>A-MDR-425-1</b> 	<b>A-MDR-500-1</b> 
Pre-made straight posts Repositionable Anatomical emergence profile Transgingival height 2.00 mm Fixation screw included	<b>A-MDR-330-2</b> 	<b>A-MDR-380-2</b> 	<b>A-MDR-425-2</b> 	<b>A-MDR-500-2</b> 
Pre-made straight posts Repositionable Anatomical emergence profile Transgingival height 4.00 mm Fixation screw included	<b>A-MDR-330-4</b> 	<b>A-MDR-380-4</b> 	<b>A-MDR-425-4</b> 	<b>A-MDR-500-4</b> 
Single pack Pack of 10 pieces  Fixation screw Supplied with the posts, it can also be ordered separately as a spare	<b>VM2-180</b> <b>VM2-180-10</b>  	Use VM2-180	<b>VM2-200</b> <b>VM2-200-10</b>  	Use VM2-200

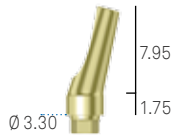
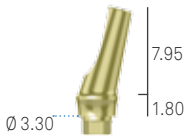
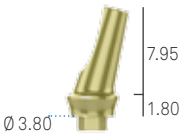
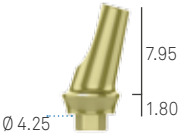
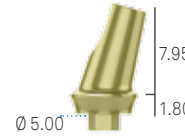
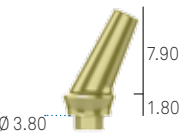
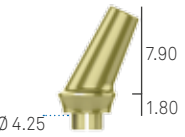
Recommended torque for fixation screws: 20-25 Ncm.

connection	Ø 3.30 mm	Ø 3.80 mm	Ø 4.25 mm	Ø 5.00 mm
Pre-made posts angled at 15° Repositionable Straight emergence profile Transgingival height 1.75 mm Fixation screw included	<b>A-MA15-330</b> 	-	-	-
Pre-made posts angled at 15° Repositionable Anatomical emergence profile Transgingival height 1.80 mm Fixation screw included	<b>A-MAR15-330</b> 	<b>A-MAR15-380</b> 	<b>A-MAR15-425</b> 	<b>A-MAR15-500</b> 
Pre-made posts angled at 25° Repositionable Anatomical emergence profile Transgingival height 1.80 mm Fixation screw included	-	<b>A-MAR25-380</b> 	<b>MAR25-425</b> 	-
Single pack Pack of 10 pieces  Fixation screw for posts Supplied with the posts, it can also be ordered separately as a spare	<b>VM2-180</b> <b>VM2-180-10</b> 	Use VM2-180	<b>VM2-200</b> <b>VM2-200-10</b> 	Use VM2-200

Recommended torque for fixation screws: 20-25 Ncm.

All measurements are given in mm, unless indicated otherwise.

# Standard millable posts



They are made of Gr. 5 titanium and are able to respond to complex anatomical requirements in terms of both narrow prosthetic spaces and parallel implants.

**Straight millable posts**, with their profile in the shape of an inverted cone, are suitable for angles of up to 10° and small profiles.



**Pre-cut posts**, allow very pronounced angles to be reached, up to 25°, limiting the time needed to reduce them by milling.

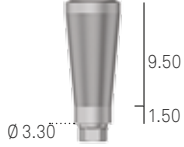
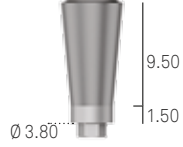
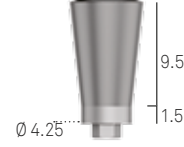
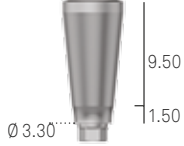
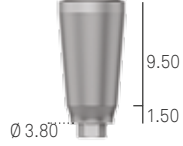
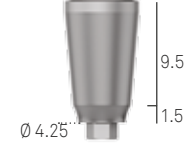
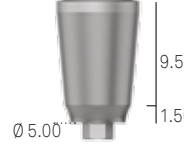
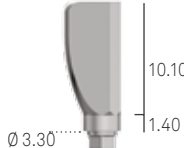
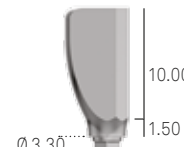
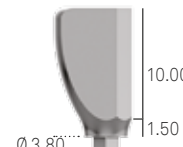
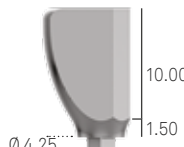
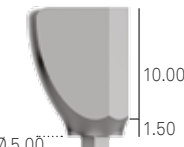

connection	Ø 3.30 mm	Ø 3.80 mm	Ø 4.25 mm	Ø 5.00 mm
Straight millable posts Repositionable Straight emergence profile Fixation screw included	<b>A-MF-330</b> 	<b>A-MF-380</b> 	<b>A-MF-425</b> 	-
Straight millable posts Repositionable Anatomical emergence profile Fixation screw included	<b>A-MFR-330</b> 	<b>A-MFR-380</b> 	<b>A-MFR-425</b> 	<b>A-MFR-500</b> 
Pre-angled millable posts Repositionable Straight emergence profile Fixation screw included	<b>A-MFP-330</b> 	-	-	-
Pre-angled millable posts Repositionable Anatomical emergence profile Fixation screw included	<b>A-MFPR-330</b> 	<b>A-MFPR-380</b> 	<b>A-MFPR-425</b> 	<b>A-MFPR-500</b> 
Single pack Pack of 10 pieces	<b>VM2-180</b> <b>VM2-180-10</b>	Use VM2-180	<b>VM2-200</b> <b>VM2-200-10</b>	Use VM2-200
Fixation screw for posts Supplied with the temporary posts, it can also be ordered separately as a spare	 M 1.8		 M 2.0	

Recommended torque for fixation screws: 20-25 Ncm.

All measurements are given in mm, unless indicated otherwise.

# Millable posts



The SIMPLE Technique allows perfect conditioning of the mucosa starting with temporary aesthetic posts (see pages 58-59) and uses a millable post with large dimensions for making a primarily custom-made final prosthesis.

The Interceptiv posts are characterised by two wide faces, which provides unequivocal repositioning on a model developed from an impression taken directly on the posts themselves.

**SIMPLE millable posts** have a very wide emergence profile which can be adapted to any anatomy which was obtained with SIMPLE temporary aesthetic posts in the immediate conditioning phase.

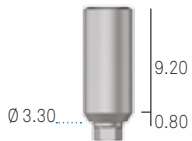
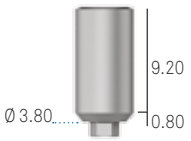
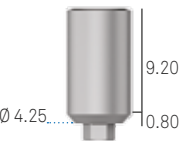
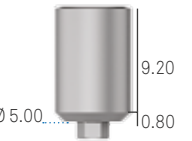
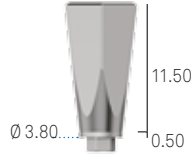
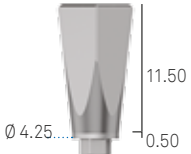
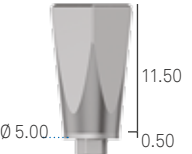

The **millable posts** for the Interceptiv Technique have two wide faces for unequivocal repositioning in the impression.

connection	Ø 3.30 mm	Ø 3.80 mm	Ø 4.25 mm	Ø 5.00 mm
Millable posts for SIMPLE technique Repositionable Very wide emergence profile Fixation screw included	<b>A-MFS-330</b> 	<b>A-MFS-380</b> 	<b>A-MFS-425</b> 	<b>A-MFS-500</b> 
Millable posts for interceptive technique Repositionable Fixation screw included	-	<b>A-MFTI-380</b> 	<b>A-MFTI-425</b> 	<b>A-MFTI-500</b> 
Single pack Pack of 10 pieces  Fixation screw for posts Supplied with the posts, it can also be ordered separately as a spare	<b>VM2-180</b> <b>VM2-180-10</b> 	Use VM2-180	<b>VM2-200</b> <b>VM2-200-10</b> 	Use VM2-200

Recommended torque for fixation screws: 20-25 Ncm.

All measurements are given in mm, unless indicated otherwise.

# B.O.P.T. prosthesis

According to the principles of the B.O.P.T. technique (Biologically Oriented Preparation Technique) a simplified line has been developed that allows you to have only two posts for Premium platforms. This is possible thanks to the particular design of the connection, different from the classic connection, which allows it to rest safely on the platform of the centring collar.



Premium Ø 3.30



Premium Ø 3.80

The same B.O.P.T. millable post **A-MEFL-330** with a 2.30 mm hexagon is used on Premium implants with Ø 3.30 and 3.80 mm.







The same B.O.P.T. millable post **A-MEFL-425** with a 2.50 mm hexagon is used on Premium implants with Ø 4.25 and 5.00 mm.

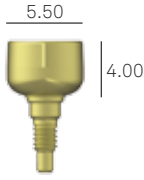
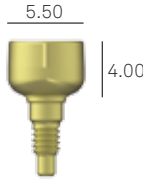

Premium Ø 4.25



Premium Ø 5.00

prosthetic component hex	2.30 mm	2.50 mm
for implants	Ø 3.30 and 3.80 mm	Ø 4.25 and 5.00 mm
B.O.P.T. healing abutment	<b>A-TMG-MEFL-330</b> 	<b>A-TMG-MEFL-425</b> 
B.O.P.T. millable post in titanium Fixation screw included	<b>A-MEFL-330</b> 	<b>A-MEFL-425</b> 
B.O.P.T. cap for taking the impression Fixation screw included	<b>CAP-MEFL-5</b> 	Use CAP-MEFL-5
Single pack Pack of 10 pieces Fixation screws for B.O.P.T. posts Supplied with the posts, it can also be ordered separately as a spare	<b>VM2-180</b> <b>VM2-180-10</b> 	<b>VM2-200</b> <b>VM2-200-10</b> 

Recommended torque for fixation screws: 20-25 Ncm.

All measurements are given in mm, unless indicated otherwise.

# Castable posts with base in alloy, titanium and cobalt chrome









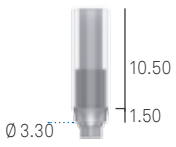
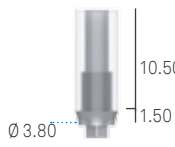
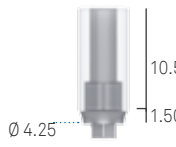
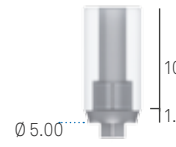
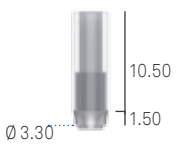
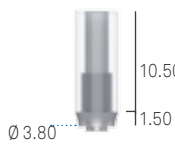
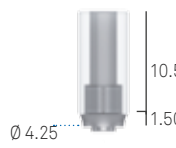
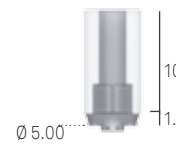
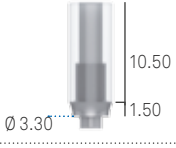
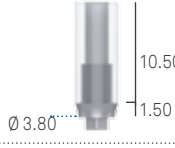
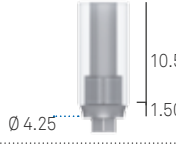
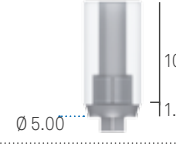

Castable posts with an alloy base combine the simplicity of castable solutions with a base of gold alloy, cobalt chrome or titanium, biocompatible materials. The melting point of the above-mentioned alloys is such as to preserve the base against dimensional alterations at the time of overcasting the castable part.

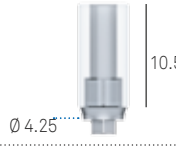
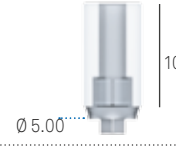

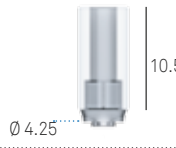
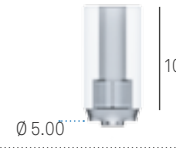
The repositionable version is suitable for creating single elements.

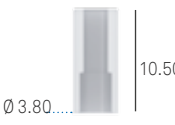
The bases are available in gold alloy, Gr. 5 titanium and cobalt chrome.

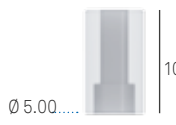
The non repositionable version presents an internal coupling cylinder which guarantees the simple insertion of multiple structures.

connection	Ø 3.30 mm	Ø 3.80 mm	Ø 4.25 mm	Ø 5.00 mm
Castable posts with a pre-made base in gold alloy Repositionable Anatomical emergence profile Fixation screw included	<b>A-UCR-330-EX</b> 	<b>A-UCR-380-EX</b> 	<b>A-UCR-425-EX</b> 	<b>A-UCR-500-EX</b> 
Castable posts with a pre-made base in gold alloy Non-repositionable Anatomical emergence profile Fixation screw included	<b>A-UCR-330</b> 	<b>A-UCR-380</b> 	<b>A-UCR-425</b> 	<b>A-UCR-500</b> 
Castable posts with pre-made base in titanium Repositionable Anatomical emergence profile Fixation screw included	<b>A-UCTR-330-EX</b> 	<b>A-UCTR-380-EX</b> 	<b>A-UCTR-425-EX</b> 	<b>A-UCTR-500-EX</b> 
Castable posts with pre-made base in cobalt chrome Repositionable Anatomical emergence profile Fixation screw included	<b>A-UCRCO-330-EX</b> 	<b>A-UCRCO-380-EX</b> 	<b>A-UCRCO-425-EX</b> 	<b>A-UCRCO-500-EX</b> 
Castable posts with pre-made base in cobalt chrome Non-repositionable Anatomical emergence profile Fixation screw included	<b>A-UCRCO-330</b> 	<b>A-UCRCO-380</b> 	<b>A-UCRCO-425</b> 	<b>A-UCRCO-500</b> 
Spare castable sleeves for castable posts with alloy base Without fixation screw	<b>A-CCUCR-330</b> 	<b>A-CCUCR-380</b> 	<b>A-CCUCR-425</b> 	<b>A-CCUCR-500</b> 
Single pack Pack of 10 pieces	<b>VM2-180</b> <b>VM2-180-10</b>	Use VM2-180	<b>VM2-200</b> <b>VM2-200-10</b>	Use VM2-200
Fixation screw for posts Supplied with the posts, it can also be ordered separately as a spare	M 1.8 		M 2.0 	

Recommended torque for fixation screws: 20-25 Ncm.











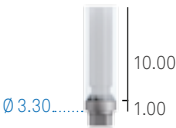
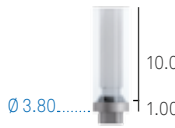

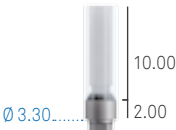

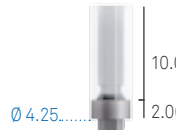

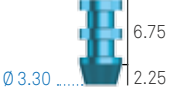

All measurements are given in mm, unless indicated otherwise.

# Prosthesis on intermediate abutments

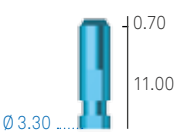
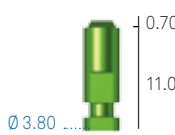
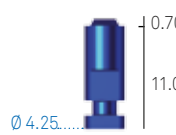
These abutments have a straight emergence profile and are made up of a repositionable Gr. 5 titanium base, characterised by a small upper cone with a height of 0.70 mm, the same for all the connection diameters, which allows insertion and removal of multiple over-structures. The abutment is supplied with a castable sleeve for modelling and casting the over-structure and with the passing screw. Normally, when these abutments are used, the impression is taken directly on the implants using the transfers. When the titanium base of the abutments is used to make a temporary post, the impression is transferred to the laboratory with the use of the special transfers and the castable sleeve is sent to the laboratory with the relative fixation screw (option available only for  $\varnothing \leq 4.25$  mm). A titanium sleeve is normally used to create the temporary prosthesis, which is supplied complete with the relative fixation screw.





connection	Ø 3.30 mm	Ø 3.80 mm	Ø 4.25 mm	Ø 5.00 mm
Straight abutments with fixation screw Repositionable Transgingival height 1.00 mm Fixation screw included	<b>A-ABU-330-1</b> 	<b>A-ABU-380-1</b> 	<b>A-ABU-425-1</b> 	<b>A-ABU-500-1</b> 
Straight abutments with fixation screw Repositionable Transgingival Height. 2.00 mm Fixation screw included	<b>A-ABU-330-2</b> 	<b>A-ABU-380-2</b> 	<b>A-ABU-425-2</b> 	<b>A-ABU-500-2</b> 
Fixation screw for abutments Supplied with the abutments, it can also be ordered separately as a spare	<b>A-VABU-180</b> 	Use A-VABU-180	<b>A-VABU-200</b> 	Use A-VABU-200
Open tray transfer for standard abutments Non-repositionable Fixation screw included	<b>A-TRABU-330</b> 	<b>A-TRABU-380</b> 	<b>A-TRABU-425</b> 	-
Single pack Spare screw for abutment transfers Supplied with the transfers, it can also be ordered separately as a spare	<b>A-VTRABU-180</b> 	Use A-VTRABU-180	<b>A-VTRABU-200</b> 	Use A-VTRABU-200
Analogue for standard abutments Non-repositionable Fixation screw included	<b>A-ANABU-330</b> 	<b>A-ANABU-380</b> 	<b>A-ANABU-425</b> 	-
Single pack Sleeves in titanium for abutments Fixation screw included	-	<b>A-CTABU-380-ROT</b> 	<b>A-CTABU-425-ROT</b> 	-
Single pack Spare castable sleeves for abutments Fixation screw not included	<b>A-CCABU-330-ROT</b> 	<b>A-CCABU-380-ROT</b> 	<b>A-CCABU-425-ROT</b> 	<b>A-CCABU-500-ROT</b> 

Recommended torque for fixation screws: 20-25 Ncm.

All measurements are given in mm, unless indicated otherwise.

# P.A.D. (Disparallel Screwed Prosthesis)

The P.A.D. components (Disparallel Screwed Prosthesis) were designed to facilitate the production of multiple screwed prostheses.

The P.A.D. angled abutments are the solution for implants positioned in distal saddles.









**P.A.D. abutments:** these all have the same upper cone, angled at 15°, which facilitates the manoeuvres of inserting and removing multiple screwed prostheses.



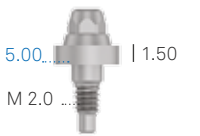

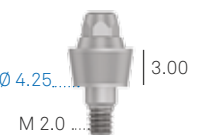
The upper cone allows further repositioning of the prosthetic structure by 15° on each side, which in the case of angled P.A.D. abutments are added to the angle of 17° or 30°. This characteristic allows easy management of disparallelism of up to 45° on each side.



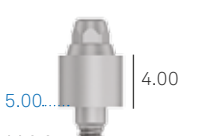











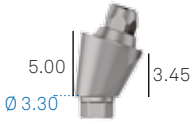

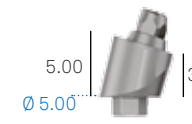
# Straight P.A.D.

connection	Ø 3.30 mm	Ø 3.80 mm	Ø 4.25 mm	Ø 5.00 mm
Straight P.A.D. abutments Direct screw-retained Transgingival height 1.50 mm	<b>A-PAD-AD330-15</b> 	<b>A-PAD-AD380-15</b> 	<b>A-PAD-AD425-15</b> 	<b>A-PAD-AD500-15</b> 
Straight P.A.D. abutments Direct screw-retained Transgingival height 3.00 mm	<b>A-PAD-AD330-30</b> 	<b>A-PAD-AD380-30</b> 	<b>A-PAD-AD425-30</b> 	<b>A-PAD-AD500-30</b> 
Straight P.A.D. abutments Direct screw-retained Transgingival height 4.00 mm	<b>A-PAD-AD330-40</b> 	<b>A-PAD-AD380-40</b> 	<b>A-PAD-AD425-40</b> 	<b>A-PAD-AD500-40</b> 

**Please note:** To transfer the straight P.A.D. abutments into the oral cavity each package contains a practical plastic carrier (code AVV-ABUT-DG, not available separately).

Recommended torque: 25-30 Ncm.

# Angled P.A.D.







connection	Ø 3.30 mm	Ø 3.80 mm	Ø 4.25 mm	Ø 5.00 mm
P.A.D. abutments angled at 17° Transgingival height 3.00 mm Fixation screw included	<b>A-PAD-AA330-173</b> 	<b>A-PAD-AA380-173</b> 	<b>A-PAD-AA425-173</b> 	<b>A-PAD-AA500-173</b> 
P.A.D. abutments angled at 17° Transgingival height 5.00 mm Fixation screw included	<b>A-PAD-AA330-175</b> 	<b>A-PAD-AA380-175</b> 	<b>A-PAD-AA425-175</b> 	<b>A-PAD-AA500-175</b> 
P.A.D. abutments angled at 30° Transgingival height 3.00 mm Fixation screw included	<b>A-PAD-AA330-303</b> 	<b>A-PAD-AA380-303</b> 	<b>A-PAD-AA425-303</b> 	<b>A-PAD-AA500-303</b> 
P.A.D. abutments angled at 30° Transgingival height 5.00 mm Fixation screw included	<b>A-PAD-AA330-305</b> 	<b>A-PAD-AA380-305</b> 	<b>A-PAD-AA425-305</b> 	<b>A-PAD-AA500-305</b> 
Single pack Pack of 10 pieces  Fixation screw for posts Supplied with the P.A.D., it can also be ordered separately as a spare	<b>PAD-VM-180</b> <b>PAD-VM-180-10</b> 	Use PAD-VM-180	<b>PAD-VM-180</b> <b>PAD-VM-180-10</b> 	Use PAD-VM-180



description	code
Carrier for transferring the angled abutments into the oral cavity, sterilisable and reusable. Not included in the surgical kit, to be purchased separately	<b>PAD-CAR</b> 

**Please note:** To transfer angled the P.A.D. abutments into the oral cavity each package contains a practical plastic carrier (code AVV-ABUT-DG, not available separately).

Recommended torque for fixation screws: 20-25 Ncm.



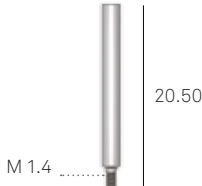
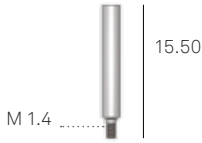
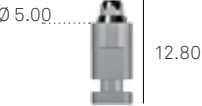
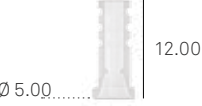

All measurements are given in mm, unless indicated otherwise.

description	code
<p>Protection caps for P.A.D. abutments in Gr. 5 titanium, to be used if the abutments remain screwed to the implant during the lab phase. Fixation screw included (code PAD-VP-140), available also as a spare, to be tightened at 8-10 Ncm</p>	<p><b>PAD-CG</b></p> 
<p>Single pack Pack of 10 pieces</p> <p>Spare screw for P.A.D. abutment prosthetic components. Supplied with all the components for making the over-structure and also available as a spare</p>	<p><b>PAD-VP-140</b> <b>PAD-VP-140-10</b></p> 
<p>Protection caps for P.A.D. abutments in PEEK, to be used if the abutments remain screwed to the implant during the lab phase. Recommended torque: 8-10 Ncm</p>	<p><b>PAD-CGP</b></p> 
<p>Rotating caps in POM for direct impression taking on P.A.D. abutments</p>	<p><b>PAD-CAP</b></p> 
<p>Non-rotating caps in POM for direct impression taking on P.A.D. abutments, with hexagon</p>	<p><b>PAD-CAP-EX</b></p> 
<p>Open tray transfer in Gr. 5 titanium for P.A.D. abutments, rotating. Long transfer screw included (code PAD-VTRAL-140), suitable for open impression tray and available also as a spare</p>	<p><b>PAD-TRA</b></p> 
<p>Open tray transfer in Gr. 5 titanium for P.A.D. abutments, with hexagon, non-rotating. Long transfer screw included (code PAD-VTRAL-140), suitable for open impression tray and available also as a spare</p>	<p><b>PAD-TRA-EX</b></p> 

description	code
Spare long screw for P.A.D. abutment transfer Supplied with the transfers, it can be ordered separately as a spare	<b>PAD-VTRAL-140</b> 
Spare screw for P.A.D. abutment transfer Supplied with the transfers, it can be ordered separately as a spare	<b>PAD-VTRA-140</b> 
Analog for P.A.D. abutment in Gr. 5 titanium	<b>PAD-ANA</b> 
Castable sleeves in PMMA for P.A.D. abutments, rotating. Fixation screw included. Attention: The recommended tightening torque for all the over-structures obtained by casting to the abutments is 20-25 Ncm. However, before casting, care must be taken in the laboratory to ensure that the castable sleeves are not fastened to the models with a torque exceeding 8-10 Ncm, because polymers are not as resistant as metal	<b>PAD-CC</b> 
Castable sleeves in PMMA for P.A.D. abutments, with hexagon, non-rotating. Fixation screw included. Attention: The recommended tightening torque for all the over-structures obtained by casting to the abutments is 20-25 Ncm. However, before casting, care must be taken in the laboratory to ensure that the castable sleeves are not fastened to the models with a torque exceeding 8-10 Ncm, because polymers are not as resistant as metal	<b>PAD-CC-EX</b> 

Recommended torque for transfer screws: 8-10 Ncm.



All measurements are given in mm, unless indicated otherwise.

description	code
<p>PEEK sleeves for P.A.D. abutments, rotating. They are specifically for creating a temporary prosthesis or in cases when it is necessary to reline an old prosthesis to be used as a temporary one. Fixation screw included, to be tightened at 20-25 Ncm</p>	<p><b>PAD-CP</b></p> 
<p>PEEK sleeves for P.A.D. abutments, with hexagon, non-rotating. They are specifically for creating a temporary prosthesis or in cases when it is necessary to reline an old prosthesis for using as a temporary one. Fixation screw included, available also as a spare</p>	<p><b>PAD-CP-EX</b></p> 
<p>Castable posts in PMMA with a pre-made base in gold alloy, rotating, not repositionable, for overcasting on P.A.D. abutments. Fixation screw included, to be tightened at 20-25 Ncm. The head of the screw never rests on the PMMA, but always on the alloy base. The castable sleeve is also available as a spare (code A-CCUCR-330)</p>	<p><b>PAD-UC</b></p> 
<p>Castable posts in PMMA with a pre-made base in cobalt chrome, rotating, non-repositionable, for overcasting on P.A.D. abutments. Fixation screw included, to be tightened at 20-25 Ncm. The head of the screw never rests on the PMMA, but always on the alloy base. The castable sleeve is also available as a spare (code A-CCUCR-330)</p>	<p><b>PAD-UCRCO</b></p> 
<p>Single pack Pack of 10 pieces</p> <p>Spare screw for P.A.D. abutment prosthetic components. Supplied with all the components for making the over-structure and also available as a spare.</p>	<p><b>PAD-VP-140</b> <b>PAD-VP-140-10</b></p> 

Recommended torque for fixation screws: 20-25 Ncm.

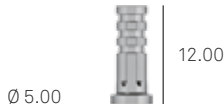
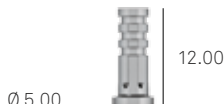

# P.A.D. components for the reline and the cemented technique

description	code
<p>Sleeves in Gr. 5 titanium for P.A.D. abutments, rotating. They are specifically for an immediate and final restoration process or for relining an old prosthesis to be used as a temporary post. Fixation screw included (code PAD-VP-140), available also as a spare</p>	<p><b>PAD-CT</b></p> 
<p>Sleeves in Gr. 5 titanium for P.A.D. abutments, with hexagon, non-rotating. They are specifically for an immediate and final restoration process or for relining an old prosthesis to be used as a temporary post. Fixation screw included (code PAD-VP-140), available also as a spare</p>	<p><b>PAD-CT-EX</b></p> 
<p>Castable posts in PMMA for cementing on titanium sleeves Effective for restoration without residual tensions</p>	<p><b>PAD-CCEM</b></p> 
<p>Single pack Pack of 10 pieces</p> <p>Spare screw for P.A.D. abutment prosthetic components Supplied with all the components for making the over-structure and also available as a spare.</p>	<p><b>PAD-VP-140</b> <b>PAD-VP-140-10</b></p> 





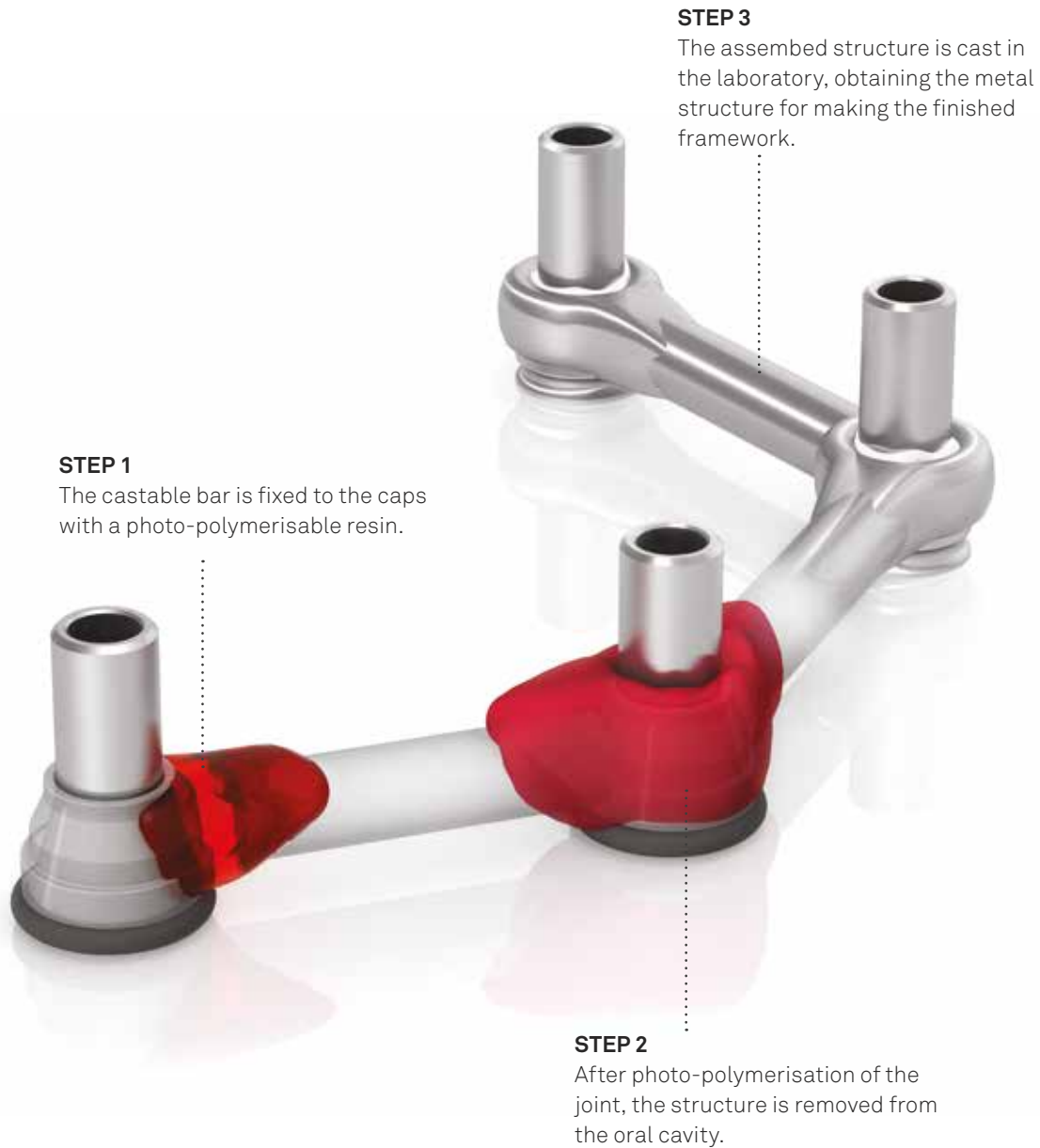

Recommended torque for fixation screws: 20-25 Ncm.

All measurements are given in mm, unless indicated otherwise.

# P.A.D. prosthesis for “D.P.F.” Technique (Direct Prosthetic Framework)

The D.P.F. components have been specially developed for creating a castable resin structure directly in the oral cavity that is absolutely passive, not restricted by connection geometries. The temporary structure created in this way can also be used as a positioning stent for making the final prosthesis.



description	code
Set of all the prosthetic components for the “D.P.F.” technique on a single P.A.D. abutment. The set includes the titanium sleeve (PAD-CT-LV), the castable centring device (PAD-CC-LV), the anti-escape plug (PAD-TR-LV), the protective O-ring (PAD-ORING-LV) and the fixation screw (PAD-VP-140) to be tightened at 20-25 Ncm, available also as a spare	<b>PAD-LV</b> 
Spare titanium sleeve for the “D.P.F.” technique. The pack does not include the fixation screw	<b>PAD-CT-LV</b> 
Spare castable centring device for the “D.P.F.” technique	<b>PAD-CC-LV</b> 
Spare anti-escape plug for the “D.P.F.” technique	<b>PAD-TR-LV</b> 
Spare O-ring for the “D.P.F.” technique	<b>PAD-ORING-LV</b> 
Single pack Pack of 10 pieces  Screw for P.A.D. abutment prosthetic components Supplied with all the components for making the framework and also available as a spare	<b>PAD-VP-140</b> <b>PAD-VP-140-10</b> 
Castable bar, length 5.00 cm, Ø 2.20 mm	<b>BARC</b> 

Recommended torque for fixation screws: 20-25 Ncm.

All measurements are given in mm, unless indicated otherwise.

# Prosthesis on PLAIN abutments





















PLAIN abutments exploit the geometry of the upper part which, by means of a very small guide, is joined to normal castable sleeves.

The usefulness of these abutments is therefore that they allow centring and repositioning operations of structures screwed onto several implants.

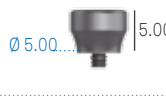
The healing caps allow optimum tissue conditioning thanks to an emergence profile that is flared at the crown. The healing caps do not have a passing screw but are inserted directly onto the abutment.



The PLAIN system also includes transfers and analogs in a single size, which allow the impression to be taken directly on the abutment. The open tray transfer has a long screw supplied with it.

connection	Ø 3.30 mm	Ø 3.80 mm	Ø 4.25 mm	Ø 5.00 mm
PLAIN abutment Direct screw-retained, Transgingival height 2.00 mm	<b>A-PLAIN-ABU330-2</b> 	<b>A-PLAIN-ABU380-2</b> 	<b>A-PLAIN-ABU425-2</b> 	<b>A-PLAIN-ABU500-2</b> 
PLAIN abutment Direct screw-retained, Transgingival height 3.00 mm	<b>A-PLAIN-ABU330-3</b> 	<b>A-PLAIN-ABU380-3</b> 	<b>A-PLAIN-ABU425-3</b> 	<b>A-PLAIN-ABU500-3</b> 
PLAIN abutment Direct screw-retained, Transgingival height 4.00 mm	<b>A-PLAIN-ABU330-4</b> 	<b>A-PLAIN-ABU380-4</b> 	<b>A-PLAIN-ABU425-4</b> 	<b>A-PLAIN-ABU500-4</b> 
Healing abutment for PLAIN abutment	<b>A-PLAIN-CG330</b> 	<b>A-PLAIN-CG380</b> 	<b>A-PLAIN-CG425</b> 	<b>A-PLAIN-CG500</b> 
Castable sleeves for PLAIN abutments Fixation screw included	<b>A-PLAIN-CC330</b> 	<b>A-PLAIN-CC380</b> 	<b>A-PLAIN-CC425</b> 	<b>A-PLAIN-CC500</b> 
Single pack Pack of 10 pieces	<b>A-PLAIN-VP200</b> <b>A-PLAIN-VP200-10</b>	Use A-PLAIN-VP200	Use A-PLAIN-VP200	Use A-PLAIN-VP200
Fixation screws for castable sleeve for PLAIN abutments Supplied with the sleeves, it can also be ordered separately as a spare	M 2.0 			

**Note:** for transferring PLAIN abutments into the oral cavity, screwing and tightening them, use the standard screwdrivers (code HSM-20-EX and HSML-20-EX for use with the torque-control ratchet) contained in the Premium surgical kit.





Recommended torque for fixation screws: 20-25 Ncm.  
Recommended torque for PLAIN abutments: 25-30 Ncm.

All measurements are given in mm, unless indicated otherwise.

# T-Connect

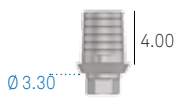
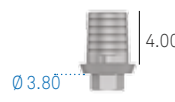
T-Connect supports can be used for making individualised posts in zirconium with open CAD CAM systems, with precision in the join between the platforms that can be obtained with traditional components.



connection	Ø 3.30 mm	Ø 3.80 mm	Ø 4.25 mm	Ø 5.00 mm
T-Connect supports in Gr. 5 titanium h. 4.00 mm for custom-made posts in zirconium Repositionable Fixation screw included	<b>A-BASTZR-S-330-4</b> 	<b>A-BASTZR-S-380-4</b> 	<b>A-BASTZR-S-425-4</b> 	<b>A-BASTZR-S-500-4</b> 
Single pack Pack of 10 pieces  Spare screw for T-Connect supports Supplied with the T-Connect supports, it can also be ordered separately as a spare	<b>VM2-180</b> <b>VM2-180-10</b> 	Use VM2-180	<b>VM2-200</b> <b>VM2-200-10</b> 	Use VM2-200

Recommended torque for fixation screws: 20-25 Ncm.

All measurements are given in mm, unless indicated otherwise.

# Try-in kit

The kit is composed of a series of try-in posts in anodised aluminium, in different angles, profiles and transgingival emergence heights, useful for checking the spaces occupied by the prosthetic posts in the model design phase.

The Plexiglass box is marked, under each seat, with the corresponding schematic drawing of the piece, with details of the dimensions and two codes; at the top, the code of the respective post to be ordered for the final prosthesis and at bottom right with the code of the Try-in, for re-ordering if required.

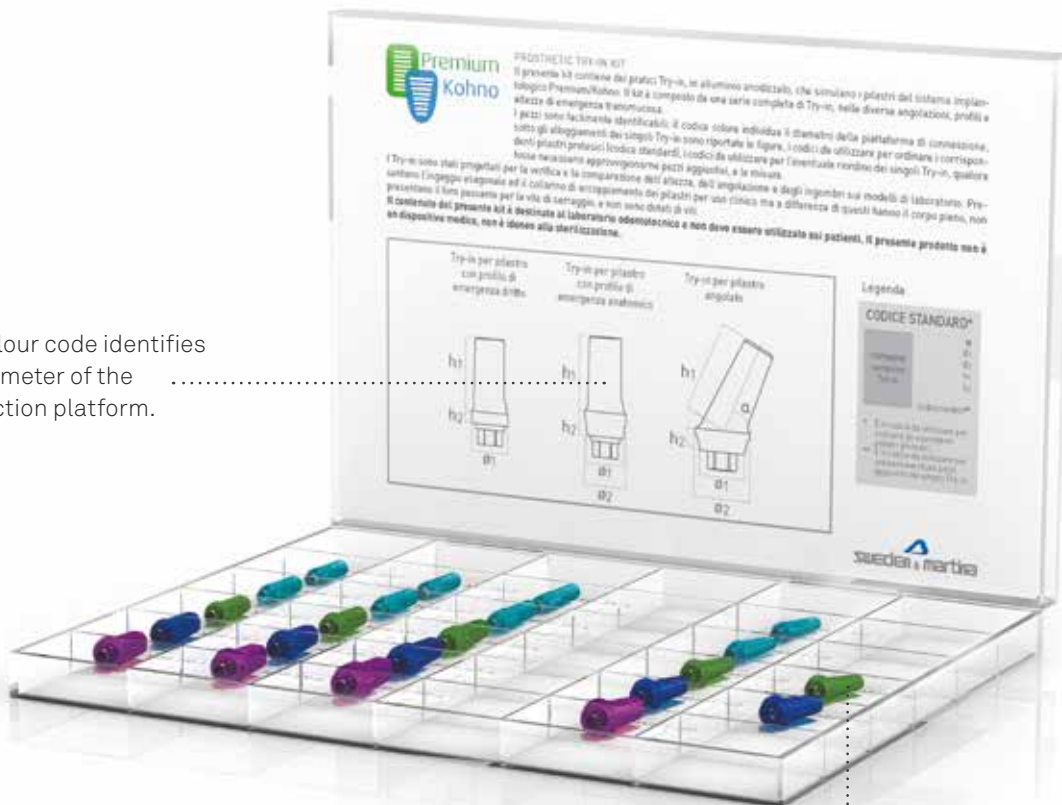

The colour code identifies the diameter of the connection platform.

Do not utilize a screw because the hexagonal connections have retentive tabs. The friction also allows the Try-in to be used in an articulator on the model of the upper arch.





description	code	
Complete Try-in kit for Premium implants (Straight and SP)	<b>A-TRY-IN-KIT-INT</b>	
Empty tray in Plexiglass	<b>A-T-TRAY-INT</b>	





# Locator Abutment

Locator Abutments\* are a patented and versatile prosthetic solution for attaching overdentures to dental implants. The Locator system corrects misalignment of divergent implants up to 40° (20° for each implant) even in limited occlusal spaces.

The abutments are made of Gr. 5 titanium and are available in different transgingival heights.

The Locators must be tightened at 25-30 Ncm, using the special driver provided in the Screw Kit and also available separately on request (code 8926-SW, short, and code 8927-SW, long).

See pages 138-139 for the list of accessories available.



The self-guiding design of the head of the Locator abutment allows easy insertion of the prosthesis.

The Locator system has a steel or titanium cap where the retainer lodges inside the prosthesis. When the retainer loses retentiveness, it can be replaced while the metal cap, remains attached to the prosthesis.

\* *Locator Abutments are medical devices manufactured and patented by Zest Anchors, Inc., 2061 Wineridge Place, Escondido, CA 92029, USA. Locator is a registered trademark of Zest Anchors, Inc. The European Agent for the purposes of MDD 93/42/EEC is Ventura Implant and Attachment Systems, 69 The Avenue, Ealing, London W13 8JR, England.*









connection	Ø 3.30 mm	Ø 3.80 mm	Ø 4.25 mm	Ø 5.00 mm
Locator Abutment Straight emergence profile Transgingival height 1.00 mm	<b>1670</b> 	<b>1675</b> 	<b>1681</b> 	<b>2724</b> 
Locator Abutment Straight emergence profile Transgingival height 2.00 mm	<b>1671</b> 	<b>1676</b> 	<b>1682</b> 	<b>2725</b> 
Locator Abutment Straight emergence profile Transgingival height 3.00 mm	<b>1672</b> 	<b>1677</b> 	<b>1683</b> 	<b>2726</b> 
Locator Abutment Straight emergence profile Transgingival height 4.00 mm	-	<b>1678</b> 	<b>1684</b> 	<b>2727</b> 
Locator Abutment Straight emergence profile Transgingival height 5.00 mm	-	<b>1679</b> 	<b>1685</b> 	-
Locator Abutment Straight emergence profile Transgingival height 6.00 mm	-	<b>1680</b> 	<b>1686</b> 	-

# Overdentures anchored with ball attachments

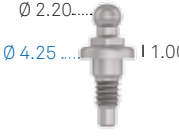
There is a small hexagon at the base of the ball for attaching the driver. This driver is compatible with the system's torque-control ratchet.

See pages 140-141 for the list of the available matrices and respective accessories.

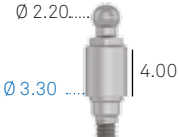
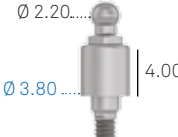
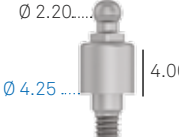

connection	Ø 3.30 mm	Ø 3.80 mm	Ø 4.25 mm	Ø 5.00 mm
Ball attachments Straight emergence profile Transgingival height 1.00 mm	<b>A-AS-330-1</b> 	<b>A-AS-380-1</b> 	<b>A-AS-425-1</b> 	-
Ball attachments Straight emergence profile Transgingival height 2.00 mm	<b>A-AS-330-2</b> 	<b>A-AS-380-2</b> 	<b>A-AS-425-2</b> 	<b>A-AS-500-2</b> 
Ball attachments Straight emergence profile Transgingival height 4.00 mm	<b>A-AS-330-4</b> 	<b>A-AS-380-4</b> 	<b>A-AS-425-4</b> 	-
Analog of the ball attachment	<b>ANAS</b> 	Use ANAS	Use ANAS	Use ANAS

description	code
Steel driver for ball attachments, with connector for torque-control ratchet or digital connector. Not included in the surgical kit, included in the Screw Kit and can be ordered separately	<b>BASCC-EX</b> 

Recommended torque for fixation screws: 25-30 Ncm.

All measurements are given in mm, unless indicated otherwise.

## SFI-Bar\*





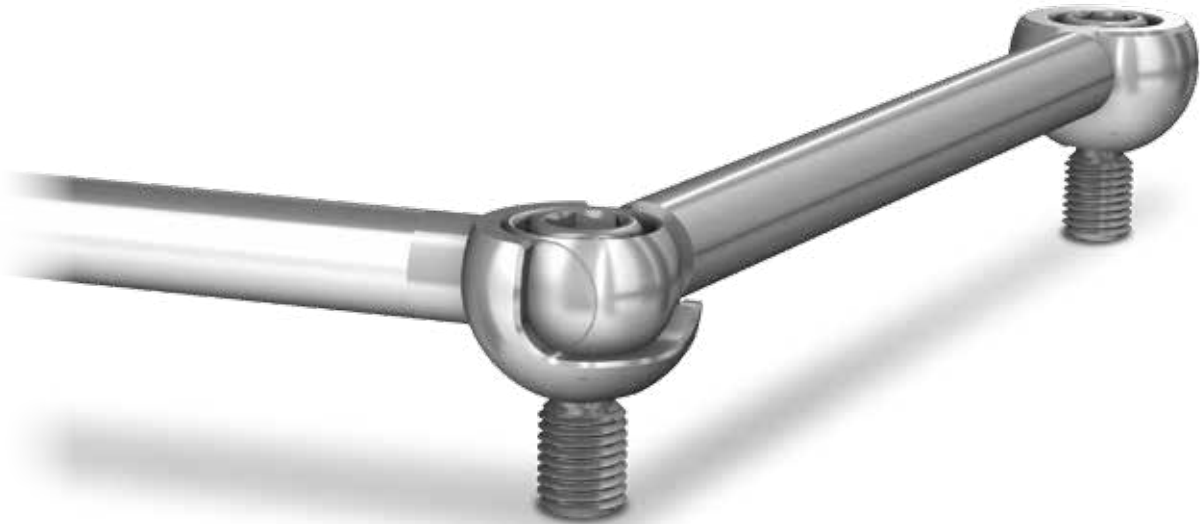

SFI-Bar can be processed either chair-side or in the laboratory. The bar prostheses made with the SFI-Bar can be supported by 3, 4, 5 or 6 implants.















In case of repair it is possible to easily replace the individual elements.



\* The components for SFI-Bar prostheses are medical devices manufactured by Cendres+Métaux, Rue de Boujean  
122 CH-2501 Biel/Bienne.



connection	Ø 3.30 mm	Ø 3.80 mm	Ø 4.25 mm	Ø 5.00 mm
Abutments for SFI-Bar Transgingival height 3.00 mm	-	<b>05001001</b> 	<b>05001007</b> 	-
Abutments for SFI-Bar Transgingival height 4.00 mm	-	<b>05001002</b> 	<b>05001008</b> 	-
Abutments for SFI-Bar Transgingival height 5.00 mm	-	<b>05001003</b> 	<b>05001009</b> 	-

description	code	
2-implant kit, including: 2 large ball joint, 2 fixation screws, 1 tube bar in Gr. 5 titanium	05000337	
4-Implant kit, including: 2 large ball joint, 2 small ball joint, 2 Half shell balls, 4 fixation screws, 3 tube bars in Gr. 5 titanium	05000338	
Add-on kit, including: 1 small ball joint, 1 half shell ball, 1 fixation screw, 1 tube bar in Gr. 5 titanium	05000668	
Tube bar, length 20 mm, in Gr. 5 titanium	05000382	
Large ball joint in Gr. 5 titanium	05000383	
Small ball joint in Gr. 5 titanium	05000384	
Half shell ball in Gr. 5 titanium	05000385	
Fixation screw in Gr. 5 titanium	05000386	
Pack of 1 piece Female part asymmetrical, length 30.00 mm in gold alloy.	05000344	
Female part complete, length 47.50 mm, in Gr. 5 titanium and plastic material. 1 bar with 12 segments, 6 yellow sheaths and 6 red sheaths	05000358	
Female part housing, length 47.50 mm in Gr. 5 titanium. 1 bar with 12 segments	05000387	
Pack of 6 pieces Yellow retention insert - smooth friction, in POM copolymer.	05000388	
Pack of 6 pieces Red retention insert - normal friction, in POM copolymer.	05000389	
Pack of 6 pieces Green retention insert - strong friction, in POM copolymer.	05000390	

description	code
Instrument set	07000108 
Spacer Brass, ensures vertical resilience. Mount between female part and bar during polymerization	052082
Transfer jig length 26.00 mm	07000107
Tube bar gauge	07000106
Gauge aid	07000100
Screwdriver	07000114
Hex key	07000115
Thomas spanner key	070221
Insert positioner	07000036
Activator set	070198
Desactivator macro	070201
Tweezers	070347
Implant planner	07000111
Premium disk No. 1	08000101





# Healing abutments for TG implants

The healing abutments are made of Gr. 5 titanium.

## Healing abutments with straight profile:





the laser marking shows the letter “M” (platform 4.80 mm) or “W” (platform 5.80 mm) and the height of the healing caps (1.30 or 2.80 mm)

**Support:** the healing abutments rest on the bevel of the implant neck.

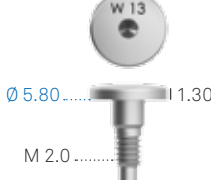
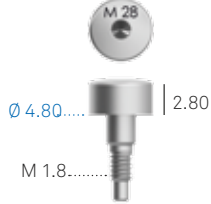
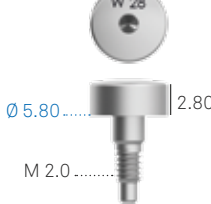

## Healing abutments with anatomical profile:

the laser marking shows the letter “M” (platform 4.80 mm) or “W” (platform 5.80 mm), the height of the caps (1.3, 2.80 or 4.30 mm) and the maximum diameter (5.40 or 6.40 mm).

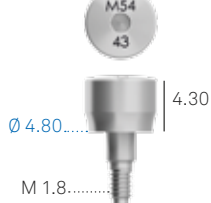
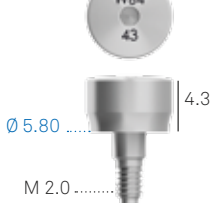
connection	M	W
Healing abutments Straight emergence profile Transgingival height 1.30 mm	<b>A-TG-TMG-M-13</b> 	<b>A-TG-TMG-W-13</b> 
Healing abutments Straight emergence profile Transgingival height 2.80 mm	<b>A-TG-TMG-M-28</b> 	<b>A-TG-TMG-W-28</b> 
Healing abutments Anatomical emergence profile Transgingival height 1.30 mm	<b>A-TG-TMGR-M-13</b> 	<b>A-TG-TMGR-W-13</b> 
Healing abutments Anatomical emergence profile Transgingival height 2.80 mm	<b>A-TG-TMGR-M-28</b> 	<b>A-TG-TMGR-W-28</b> 
Healing abutments Anatomical emergence profile Transgingival height 4.30 mm	<b>A-TG-TMGR-M-43</b> 	<b>A-TG-TMGR-W-43</b> 

Recommended torque for healing abutments: 8-10 Ncm.

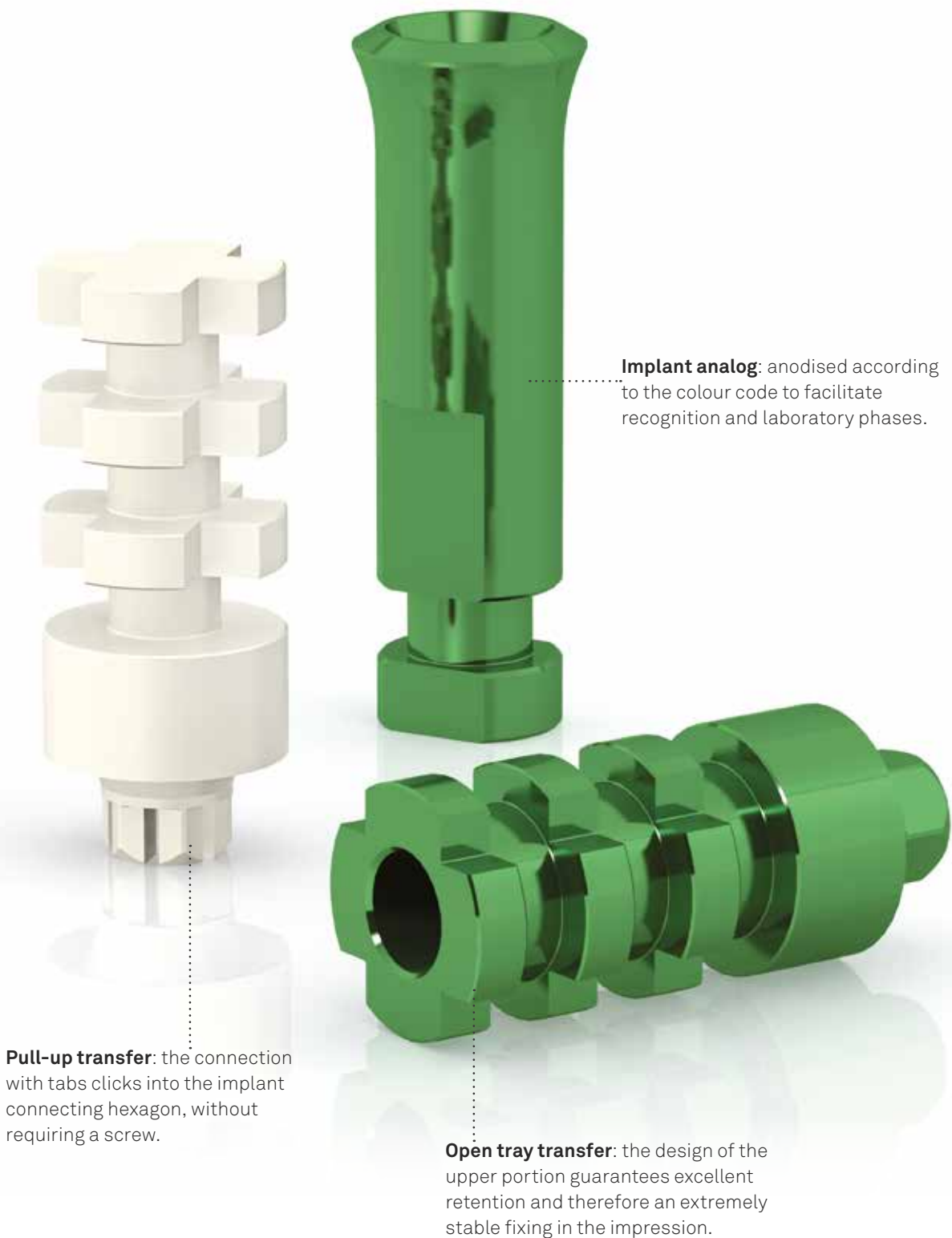

# Impression and model phase

The open tray transfers are made of Gr. 5 titanium, anodised according to the colour code of the reference platform, facilitating the identification of any different diameters that may be used. The pull-up transfer is made of radiopaque PEEK to allow checking of the correct insertion in the implant platform.





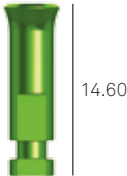

### Analogs

connection	M	W
Analogs	<b>A-TG-ANA-M</b> 	<b>A-TG-ANA-W</b> 

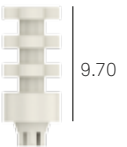
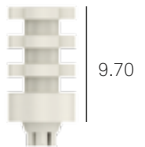
### Pull-up transfer

connection	M	W
Pull-up transfers in radiopaque PEEK Straight emergence profile	<b>A-TG-TRAP-M</b> 	<b>A-TG-TRAP-W</b> 

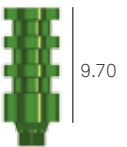
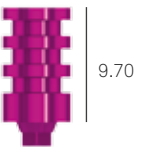
### Open tray transfer

connection	M	W
Open tray transfer Straight emergence profile Fixation screw included	<b>A-TG-TRA-M</b> 	<b>A-TG-TRA-W</b> 
Single pack Spare screws for open tray transfer Supplied with the transfers, it can also be ordered separately as a spare	<b>A-TG-VTRA-180-20</b> 	<b>A-TG-VTRA-200-20</b> 

Recommended torque for transfer screws: 8-10 Ncm.

All measurements are given in mm, unless indicated otherwise.

# SIMPLE temporary posts

The SIMPLE prosthetic protocol calls for creating the temporary posts. They are made in Gr. 5 titanium or in PEEK with titanium base, and are available in repositionable and non-repositionable version.



**PEEK** post with titanium base for cement-retained single crowns.



**Temporary post with hexagon** for making single screwed temporary posts.

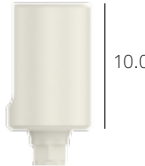
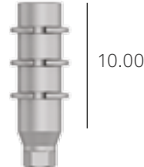
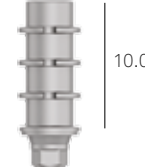
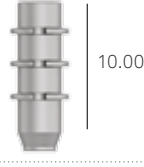
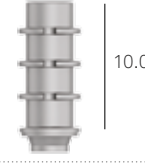

**Aesthetic temporary post** with the widest flaring of the transgingival profile, adaptable to any anatomy by drilling, for aesthetic conditioning of the mucosa.

connection	M	W
<p>SIMPLE temporary posts in PEEK                      Repositionable                      With closure on the shoulder of the implant                      Fixation screw included</p>	<p><b>A-TG-MPSP-M</b></p> 	<p><b>A-TG-MPSP-W</b></p> 
<p>SIMPLE temporary posts in Gr. 5 titanium                      Repositionable                      With emergence inside the connection platform                      Fixation screw included</p>	<p><b>A-TG-MPST-M</b></p> 	<p><b>A-TG-MPST-W</b></p> 
<p>SIMPLE temporary posts in Gr. 5 titanium                      Non-repositionable                      With emergence inside the connection platform                      Fixation screw included</p>	<p><b>A-TG-MPST-M-ROT</b></p> 	<p><b>A-TG-MPST-W-ROT</b></p> 
<p>Single pack                      Pack of 10 pieces</p> <p>Spare screw for temporary posts                      Supplied with the temporary posts, it can also be ordered separately as a spare</p>	<p><b>A-TG-VM-180</b>  <b>A-TG-VM-180-10</b></p>  <p>M 1.8.....</p>	<p><b>A-TG-VM-180</b>  <b>A-TG-VM-180-10</b></p>  <p>M 2.0.....</p>







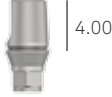

Recommended torque for fixation screws: 20-25 Ncm.

# Pre-made straight posts

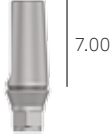
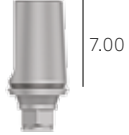
Made of Gr. 5 titanium, these posts exploit the conical support and present a hexagon that allows them to be repositioned. The straight posts emerge inside the connection platform, to allow closure of the crowns on the neck of the implant.



**Hexagon:** for repositioning and the non-rotational aspect; this type of post is therefore indicated for making single structures.

connection	M	W
Pre-made straight posts Repositionable. With emergence inside the connection platform height 4.00 mm Fixation screw included	<b>A-TG-MR-M-40</b>   4.00	<b>A-TG-MR-W-40</b>   4.00
Pre-made straight posts Repositionable. With emergence inside the connection platform height 7.00 mm Fixation screw included	<b>A-TG-MR-M-70</b>   7.00	<b>A-TG-MR-W-70</b>   7.00
Castable caps in POM for modelling on straight pre-made direct screw- retained posts Repositionable	<b>A-TG-CAPCM-M</b>   8.20	<b>A-TG-CAPCM-W</b>   8.20
Castable caps in POM for modelling on straight pre-made direct screw- retained posts Non-repositionable	<b>A-TG-CAPCM-M-ROT</b>   8.20	<b>A-TG-CAPCM-W-ROT</b>   8.20
Single pack Pack of 10 pieces  Spare screw for posts. Supplied with the pre- made posts, it can also be ordered separately as a spare	<b>A-TG-VM-180</b> <b>A-TG-VM-180-10</b>   M 1.8.....	<b>A-TG-VM-180</b> <b>A-TG-VM-180-10</b>   M 2.0.....

**Note:** Should it be necessary to take the impression directly on the post without removing it from the implant connection, use the dedicated accessories for direct screw-retained straight posts (see from page 124).

Recommended torque for fixation screws: 20-25 Ncm.

All measurements are given in mm, unless indicated otherwise.









# Angled pre-made posts

Made of Gr. 5 titanium, these posts rest on the shoulder of the implant.



**Angled posts:** with a fixation screw they offer 15° or 20° angles.

**20° angled pre-made posts:** they can be screwed to any over-structure. They have an M 1.4 threaded hole on the head for receiving the prosthetic screw to fasten to the over-structures.

connection	M	W
15° angled pre-made posts Repositionable With emergence inside the connection platform Fixation screw included	<b>A-TG-MAR15-M-60</b>   6.00	<b>A-TG-MAR15-W-60</b>   6.00
20° angled pre-made posts with set-up for screwed prosthesis Repositionable With closure on the shoulder of the implant Fixation screw included	<b>A-TG-MAPA20-M</b>   5.90	<b>A-TG-MAPA20-W</b>   5.90
Castable sleeve in PMMA for modelling over- structures on 20° pre-angled posts Fixation screw included	<b>A-TG-CC-MAPA-M</b>   5.90	<b>A-TG-CC-MAPA-W</b>   5.90
Single pack Pack of 10 pieces  Spare screw for posts Supplied with the pre- made posts, it can also be ordered separately as a spare	<b>A-TG-VM-180</b> <b>A-TG-VM-180-10</b>   M 1.8	<b>A-TG-VM-200</b> <b>A-TG-VM-200-10</b>   M 2.0
Single pack Pack of 10 pieces  Spare screws for fastening over-structures on 20° pre-angled posts Supplied with the pre- made posts, it can also be ordered separately as a spare	<b>A-TG-VP-140</b> <b>A-TG-VP-140-10</b>   M 1.4	Use A-TG-VP-140

Recommended torque for post fixation screws: 20-25 Ncm. When screwing the sleeves on the post during the modelling phase, it is recommended not to exceed a torque value of 6-8 Ncm.

## Standard millable posts







They are made of Gr. 5 titanium and are able to respond to complex anatomical requirements in terms of both narrow prosthetic spaces and disparallel implants.

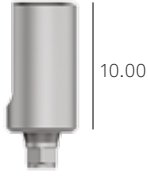

Straight millable posts, with their profile in the shape of an inverted cone, are suitable for angles of up to 10° and small profiles.

The millable posts are available both with the emergence inside the implant connection and resting on the external shoulder of the implant.



connection	M	W
<p>Straight millable posts                      Repositionable                      With emergence inside the connection platform                      Fixation screw included</p>	<p><b>A-TG-MFI-M</b></p> 	<p><b>A-TG-MFI-W</b></p> 
<p>Straight millable posts                      Repositionable                      With closure on the shoulder of the implant                      Fixation screw included</p>	<p><b>A-TG-MFE-M</b></p> 	<p><b>A-TG-MFE-W</b></p> 
<p>Single pack                      Pack of 10 pieces</p> <p>Spare screw for posts                      Supplied with the millable posts, it can also be ordered separately as a spare</p>	<p><b>A-TG-VM-180</b>  <b>A-TG-VM-180-10</b></p> 	<p><b>A-TG-VM-200</b>  <b>A-TG-VM-200-10</b></p> 

Recommended torque for fixation screws: 20-25 Ncm.

All measurements are given in mm, unless indicated otherwise.

# Castable posts with alloy base



This solution combines the simplicity of castable solutions with a gold alloy base that is biocompatible. The melting point of the alloy is such as to preserve the base against dimensional alterations at the time of overcasting the castable part.



The repositionable version is suitable for creating single elements.

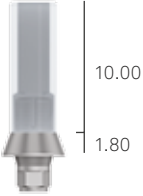
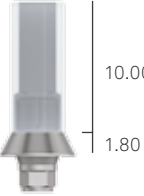
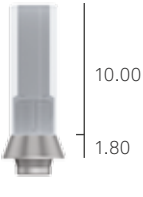
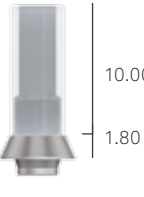
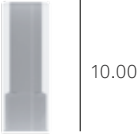
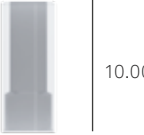

The non repositionable version presents a cylinder which, when inscribed in the hexagon of the connection, helps the insertion of multiple structures.

connection	M	W
<p>Castable posts with a pre-made base in gold alloy Repositionable. With closure on the shoulder of the implant Fixation screw included</p>	<p><b>A-TG-UC-M</b></p> 	<p><b>A-TG-UC-W</b></p> 
<p>Castable posts with a pre-made base in gold alloy Non-repositionable. With closure on the shoulder of the implant Fixation screw included</p>	<p><b>A-TG-UC-M-ROT</b></p> 	<p><b>A-TG-UC-W-ROT</b></p> 
<p>Single pack Spare castable sleeve for castable posts with gold alloy base Fixation screw not included</p>	<p><b>A-TG-CCUC-M</b></p> 	<p><b>A-TG-CCUC-W</b></p> 
<p>Single pack Pack of 10 pieces Spare screw for castable posts with alloy base Supplied with the castable posts, it can also be ordered separately as a spare</p>	<p><b>A-TG-VM-180</b> <b>A-TG-VM-180-10</b></p> 	<p><b>A-TG-VM-200</b> <b>A-TG-VM-200-10</b></p> 

Recommended torque for fixation screws: 20-25 Ncm.



All measurements are given in mm, unless indicated otherwise.

# Prosthesis on intermediate abutments

The repositionable abutments are made up of an element fitted with a lower hexagon that allows repositioning them inside the implant connection, and of an upper hexagon that allows repositioning the over-structures. The abutments have a through hole that allows the fixation screw to pass through to the implants. A thread is present inside the head of the screw that secures the abutment to the implant for screwing the over-structure.



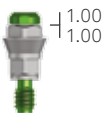
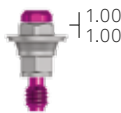





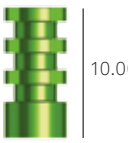
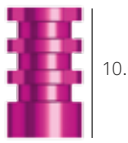
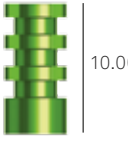
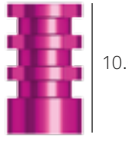
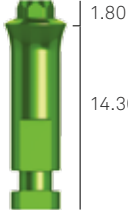

All the prosthetic components for taking the impression directly on the abutments are available.

connection	M	W
<p>Straight abutments Repositionable With emergence inside the connection platform Fixation screw included</p>	<p><b>A-TG-ABUR-M</b></p> 	<p><b>A-TG-ABUR-W</b></p> 
<p>Single pack Pack of 10 pieces</p> <p>Spare screw for fastening repositionable intermediate abutments Supplied with the abutments, it can also be ordered separately as a spare</p>	<p><b>A-TG-VABUR-M</b> <b>A-TG-VABUR-M-10</b></p>  <p>M 1.8</p>	<p><b>A-TG-VABUR-W</b> <b>A-TG-VABUR-W-10</b></p>  <p>M 2.0</p>

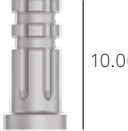
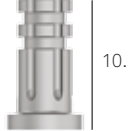
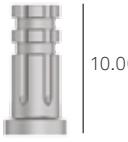
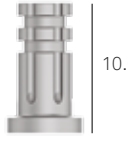
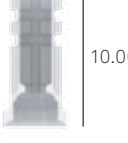
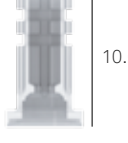
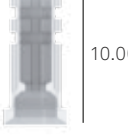
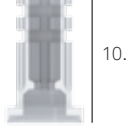
description	code
<p>Steel carrier/driver for repositionable abutments. It connects to the external hexagon on the head of the fixation screws of the two connections "M" and "W" (code A-TG-VABUR-M and A-TG-VABUR-W respectively)</p>	<p><b>A-TG-AVVABUR</b></p> 

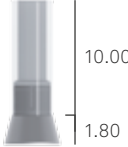
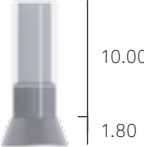
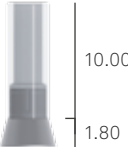
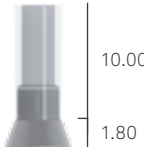
Recommended torque for fixation screws: 20-25 Ncm.

connection	M	W
Healing caps for abutments With straight emergence profile Fixation screw included	<b>A-TG-CAPGABU-M</b> 	<b>A-TG-CAPGABU-W</b> 
Open tray transfers for abutments Repositionable With straight emergence profile Fixation screw included	<b>A-TG-TRABU-M</b> 	<b>A-TG-TRABU-W</b> 
Open tray transfers for abutments Non-repositionable With straight emergence profile Fixation screw included	<b>A-TG-TRABU-M-ROT</b> 	<b>A-TG-TRABU-W-ROT</b> 
Abutment analogs	<b>A-TG-ANABU-M</b> 	<b>A-TG-ANABU-W</b> 
Sleeves in titanium for abutments Repositionable With straight emergence profile Fixation screw included	<b>A-TG-CTABU-M</b> 	<b>A-TG-CTABU-W</b> 
Sleeves in titanium for abutments Non-repositionable With straight emergence profile Fixation screw included	<b>A-TG-CTABU-M-ROT</b> 	<b>A-TG-CTABU-W-ROT</b> 
Castable sleeves for abutments Repositionable With straight emergence profile Fixation screw included	<b>A-TG-CCABU-M</b> 	<b>A-TG-CCABU-W</b> 
Castable sleeves for abutments Non-repositionable With straight emergence profile Fixation screw included	<b>A-TG-CCABU-M-ROT</b> 	<b>A-TG-CCABU-W-ROT</b> 

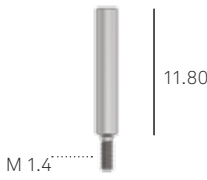
connection	M	W
Castable posts with a pre-made base in gold alloy for abutments Repositionable With straight emergence profile Fixation screw included	<b>A-TG-UCABU-M</b> 	<b>A-TG-UCABU-W</b> 
Castable posts with a pre-made base in gold alloy for abutments Non-repositionable With straight emergence profile Fixation screw included	<b>A-TG-UCABU-M-ROT</b> 	<b>A-TG-UCABU-W-ROT</b> 
Spare castable sleeves for castable posts with gold alloy base Fixation screw not included	<b>A-TG-CCUC-M</b> 	<b>A-TG-CCUC-W</b> 
Single pack Pack of 10 pieces  Spare screw for healing caps for sleeves and posts with alloy base Supplied with the sleeves and posts, it can also be ordered separately as a spare	<b>A-TG-VP-140</b> <b>A-TG-VP-140-10</b>  	Use A-TG-VP-140
Single pack  Spare screw for open tray transfers for intermediate abutments Supplied with the sleeves and posts, it can also be ordered separately as a spare	<b>A-TG-VTRABU-140</b>  	Use A-TG-VTRABU-140

Recommended torque for fixation screws: 20-25 Ncm.  
 Recommended torque for transfer screws: 8-10 Ncm.



All measurements are given in mm, unless indicated otherwise.

# T-Connect

T-Connect supports can be used for making custom-made prostheses in zirconium with open CAD CAM systems with precision in the joint between the platforms that can be obtained with traditional components.



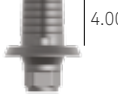

connection	M	W
<p>T-Connect supports h. 4.00 mm in Gr. 5 titanium for custom-made posts in zirconium Repositionable Fixation screw included</p>	<p><b>A-TG-BASTZR-S-M-4</b></p>  <p>4.00</p>	<p><b>A-TG-BASTZR-S-W-4</b></p>  <p>4.00</p>
<p>Single pack Pack of 10 pieces</p> <p>Spare screws for supports for custom-made posts Supplied with the supports for custom-made posts, it can also be ordered separately as a spare</p>	<p><b>A-TG-VM-180</b> <b>A-TG-VM-180-10</b></p>  <p>M 1.8</p>	<p><b>A-TG-VM-200</b> <b>A-TG-VM-200-10</b></p>  <p>M 2.0</p>

Recommended torque for fixation screws: 20-25 Ncm.



Premium TG (Transgingival)  
prosthetic components,  
direct screw-retained





# Solid one-piece abutments

Made of Gr. 5 titanium, these posts make use of the conical coupling and, once secured, cannot be removed from their seat in the normal manner. They are screwed directly onto the implant connections and have a small well on the head, inside which is inserted the standard screwdriver of the securing system (HSM family see page 42 for the codes).

All the accessories (protection caps, for taking the impression and for waxing) are stabilised on the cone of the straight posts thanks to their design which allows them to click into place.

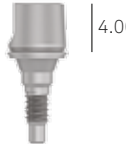
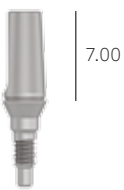
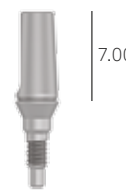







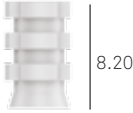

**Repositionable castable caps:** the dot seen on the outside corresponds to the internal indexing face.

connection	M	W
<p>Straight solid one-piece abutments with emergence inside the connection platform Height 4.00 mm</p>	<p><b>A-TG-MD-M-40</b></p> 	<p><b>A-TG-MD-W-40</b></p> 
<p>Straight solid one-piece abutments with emergence inside the connection platform Height 7.00 mm</p>	<p><b>A-TG-MD-M-70</b></p> 	<p><b>A-TG-MD-W-70</b></p> 
<p>Healing caps in PEEK for straight solid one-piece abutment with straight emergence profile Height 4.00 mm</p>	<p><b>A-TG-CAPGM-M-40</b></p> 	<p><b>A-TG-CAPGM-W-40</b></p> 
<p>Healing cap in PEEK for straight solid one-piece abutment with straight emergence profile Height 7.00 mm</p>	<p><b>A-TG-CAPGM-M-70</b></p> 	<p><b>A-TG-CAPGM-W-70</b></p> 

Recommended torque: 25-30 Ncm.

All measurements are given in mm, unless indicated otherwise.

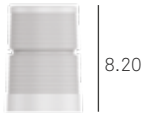
connection	M	W
<p>Snap-on caps in POM for closed tray impression on straight solid one-piece abutments</p>	<p><b>A-TG-CAPIM-M</b></p> 	<p><b>A-TG-CAPIM-W</b></p> 
<p>Analogs for straight solid one-piece abutment pre-made posts Height 4.00 mm</p>	<p><b>A-TG-ANAM-M-40</b></p> 	<p><b>A-TG-ANAM-W-40</b></p> 
<p>Analogs for straight solid one-piece abutment pre-made posts Height 7.00 mm</p>	<p><b>A-TG-ANAM-M-70</b></p> 	<p><b>A-TG-ANAM-W-70</b></p> 

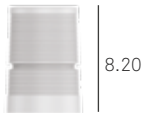
connection	M	W
<p>Castable caps in POM for modelling on straight solid one-piece abutment Repositionable</p>	<p><b>A-TG-CAPCM-M</b></p> 	<p><b>A-TG-CAPCM-W</b></p> 
<p>Castable caps in POM for modelling on straight solid one-piece abutment Non-repositionable</p>	<p><b>A-TG-CAPCM-M-ROT</b></p> 	<p><b>A-TG-CAPCM-W-ROT</b></p> 

# Prosthesis on intermediate abutments

Once screwed to the implants, the direct screw-retained abutments cannot be removed. The upper part of these abutments has an external hexagon with the same tapering as repositionable abutments, therefore the components for creating the over-structures are the same and compatible for both types of abutments.





All the prostheses and accessories necessary for making the over-structures are the same ones that can be used with abutments with a fixation screw (see from page 116).

The head of the abutment has a hexagonal shape on the outside which allows it to be screwed using the appropriate driver (code AVV2-ABUT).

At the head the hexagon has a thread onto which the over-structure will be screwed at a later stage.



connection	M	W
Straight abutments Non-repositionable. With emergence inside the connection platform	<b>A-TG-ABUD-M</b>  	<b>A-TG-ABUD-W</b>  

description	code
Driver for non-repositionable abutments <i>Included in the Screw Kit, it can also be ordered separately</i>	<b>AVV2-ABUT</b>  

Recommended torque: 25-30 Ncm.

All measurements are given in mm, unless indicated otherwise.



# Premium TG (Transgingival) Overdentures

# Locator abutments

Locator Abutments\* are a patented and versatile prosthetic solution for attaching overdentures to dental implants. The Locator system corrects misalignment of divergent implants up to 40° (20° for each implant) even in limited occlusal spaces.

The abutments are made of Gr. 5 titanium and are available in different transgingival heights. The Locators must be tightened at 25-30 Ncm, using the special driver provided in the Screw Kit and also available separately on request (code 8926-SW, short, and code 8927-SW, long). See pages 138-139 for the list of accessories available.

The abutments for the “M” connection exploit the conical support with emergence inside the implant connection; the abutments for the “W” connection rest on the shoulder of the implant.



The self-guiding design of the head of the Locator abutment allows easy insertion of the prosthesis.



The Locator system has a steel or titanium cap where the retainer lodges inside the prosthesis. When the retainer loses retentiveness, it can be replaced metal cap while remains attached to the prosthesis.

\* *Locator Abutments are medical devices manufactured and patented by Zest Anchors, Inc., 2061 Wineridge Place, Escondido, CA 92029, USA. Locator is a registered trademark of Zest Anchors, Inc. The European Agent for the purposes of MDD 93/42/EEC is Ventura Implant and Attachment Systems, 69 The Avenue, Ealing, London W13 8JR, England.*

connection	M	W
Locator Abutments Non-repositionable Height 0.20 mm	<b>2087</b> 	-
Locator Abutments Non-repositionable Height 1.00 mm	<b>2088</b> 	<b>2081</b> 
Locator Abutments Non-repositionable Height 2.00 mm	<b>2089</b> 	<b>2082</b> 

description	code
Short driver in Gr. 5 titanium for screwing the Locator abutments. The driver is compatible with the torque-control ratchet. Included in the Screw kit, it can be ordered separately	<b>8926-SW</b> 
Long driver in Gr. 5 titanium for screwing the Locator abutments. The driver is compatible with the torque-control ratchet. Included in the Screw kit, it can be ordered separately	<b>8927-SW</b> 

# Overdentures anchored with ball attachments

There is a small hexagon at the base of the ball for attaching the driver. This driver is compatible with the system's torque-control ratchet.

See page 140-141 for the list of the available matrices and respective accessories.

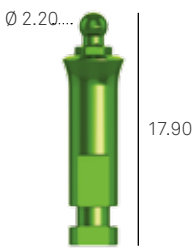

connection	M	W
<p>Ball attachment Non-repositionable With emergence inside the connection platform</p>	<p><b>A-TG-AS-M</b></p>  <p>Ø 2.20...</p> <p>M 1.8...</p>	-
<p>Analog of the ball attachment</p>	<p><b>A-TG-ANAS-M</b></p>  <p>Ø 2.20...</p> <p>17.90</p>	-

description	code
<p>Steel driver for ball attachments, with connector for torque-control ratchet or digital connector. <i>Not included in the surgical kit, included in the Screw Kit and can be ordered separately</i></p>	<p><b>BASCC-EX</b></p> 

Recommended torque: 25-30 Ncm.











All measurements are given in mm, unless indicated otherwise.

















# Accessories for overdentures on Locator abutments

description	code
Kit containing 2 Gr. 5 titanium caps, 2 spacer rings in silicon rubber, 2 black processing polyethylene retainers (LDPE) with low retention capacity and 2 nylon retainers for each of the 4 different retention capacities	<b>8519-2</b> 
Kit containing 2 Gr. 5 titanium caps, 2 spacer rings in silicon rubber, 2 black processing polyethylene retainers (LDPE) with low retention capacity and 2 nylon retainers for each of the 4 different retention capacities, designed for severe disparallelism	<b>8540-2</b> 
Kit containing 2 steel caps, 2 spacer rings in silicon rubber, 2 black processing polyethylene retainers (LDPE) with low retention capacity and 2 nylon retainers for each of the 4 different retention capacities	<b>8550-2</b> 
Pack of 20 spacer rings in silicon rubber	<b>8514</b> 
Pack of 4 black processing polyethylene retainers (LDPE) with low retention capacity	<b>8515</b> 
Pack of 4 transparent nylon retainers, retention 5 lb	<b>8524</b> 
Pack of 4 pink nylon retainers, retention 3 lb	<b>8527</b> 
Pack of 4 blue nylon retainers, retention 1.5 lb	<b>8529</b> 
Pack of 4 green nylon retainers, retention 4 lb	<b>8547</b> 
Pack of 4 red nylon retainers, retention 1 lb	<b>8548</b> 
Pack of 4 orange nylon retainers, retention 2 lb	<b>8915</b> 



description	code
Pack of 4 aluminium analogs for Locator abutments, one size for all platforms	8530 
Pack of 4 aluminium transfers for Locator abutments, one size for all platforms. 4 black polyethylene retainers (LDPE) with low retention included (code 8515), available also as a spare	8505 
Pack of 4 black nylon parallelism pins (LDPE) for Locator abutments	8517 
Steel plate AISI 316L for measuring angles	9530 
Locator Core Tool. Steel instrument composed of a handle, driver (8390) for inserting Locator abutments, tip (8397) for inserting the retainers in the caps and the retention jacket (8394) for the driver (8390) for transferring the Locator abutments into the oral cavity	8393 
Replacement of the steel tip for inserting the retainers into the caps	8397 
Replacement of the steel driver for abutment screwing/unscrewing	8390 
Replacement of the retention jacket for the driver (8390) for transferring the Locator abutments into the oral cavity	8394 
Short driver in Gr. 5 titanium for torquing the Locator abutments. The driver is compatible with the torque-control ratchet	8926-SW 
Long driver in Gr. 5 titanium for torquing the Locator abutments. The driver is compatible with the torque-control ratchet	8927-SW 

Locator Abutments are medical devices manufactured and patented by Zest Anchors, Inc., 2061 Wineridge Place, Escondido, CA 92029, USA. Locator is a registered trademark of Zest Anchors, Inc. The European Agent for the purposes of MDD 93/42/EEC is Ventura Implant and Attachment Systems, 69 The Avenue, Ealing, London W13 8JR, England.





All measurements are given in mm, unless indicated otherwise.

# Accessories for overdentures on ball attachments

## Polyamide caps for ball attachments

description	code
Polyamide cap for ball attachments $\varnothing$ 2.20 mm	CAP-TFL-1 
Steel container for polyamide cap with outer $\varnothing$ 4.80 mm. The total height is 3.20 mm	CONT-CAP-TFL-1 





## Titanium caps for ball attachments

description	code
Gr. 5 titanium cap complete with cap in two parts, titanium retention spring, and plastic mounting ring for ball attachments $\varnothing$ 2.20 mm. The total height is 3.20 mm	CAP-TIT-1 
Spare plastic ring for titanium cap height 2.20 mm	AN-CAP-TIT-1 
Spare retention spring for titanium caps, average hardness, steel, $\varnothing$ 3.20 mm	MOL1-CAP-TIT-1 
Spare retention spring for titanium cap, soft, for progressive adaptation of the prosthesis, steel, $\varnothing$ 3.20 mm	MOL2-CAP-TIT-1 
Instrument for assembly and maintaining the titanium cap for CAP-TIT-1 ball attachments	AVV-CAP-TIT-1 

## Caps in gold alloy for ball attachments





description	code
Cap in gold alloy, complete with plastic positioning ring for ball attachments $\varnothing$ 2.20 mm. The total height is 3.10 mm, and the outside diameter is 3.50 mm	CAP-1 

## O-ring retention devices for ball attachments

description	code	
Pack of 6 pieces Metal container in the shape of a ring for rubber O-rings. For ball attachments $\varnothing$ 2.20 mm. The total height is 1.50 mm, and the outside diameter is 4.50 mm.	99-440044*	
Pack of 12 pieces Red ring in silicon for laboratory use, outside $\varnothing$ 4.50 mm, height 1.50 mm.	99-443034*	
Pack of 12 pieces White ring in natural rubber, soft, outside $\varnothing$ 4.50 mm, height 1.50 mm.	99-443035*	
Pack of 12 pieces Black ring in natural rubber, hard, outside $\varnothing$ 4.50 mm, height 1.50 mm.	99-443036*	

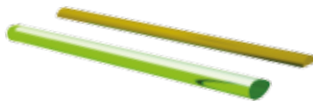
\* The retention O-rings for ball attachments are manufactured by Implant Direct Sybron International, 3050 East Hillcrest Drive, Thousand Oaks, CA 91362 U.S.A.  
The European Agent for the purposes of MDD 93/42/EEC is Kerr Italia S.r.l., via Passanti 332, 84018 Scafati (SA) Italy.

## Overdentures on bars

description	code	
Castable bar, length 5.00 cm, height 3.00 mm, thickness 1.90 mm Ovoid-shaped profile with spacer	BARC-CAV-TIT	
Divisible bar attachment in titanium for oval bars with $\varnothing$ 1.90 mm and height 3.00 mm	CAV-TIT	
Castable bar, length 5.00 cm, $\varnothing$ 1.90 mm	BARC	
Bar attachment in gold alloy, for round bars with $\varnothing$ 1.90 mm	CAV-375	

All measurements are given in mm, unless indicated otherwise.







rev. 01-16



**Sweden & Martina S.p.A.**

Via Veneto, 10  
35020 Due Carrare (PD), Italy  
Tel. +39.049.9124300  
Fax +39.049.9124290  
info@sweden-martina.com  
www.sweden-martina.com

**Sweden & Martina Mediterranea S.L.**

Sorolla Center, Oficina 801  
Avda Cortes Valencianas 58, 8pl  
46015-Valencia, Spain  
Tel. +34.96.3525895  
Tel. 900993963  
info.es@sweden-martina.com

**Sweden & Martina Deutschland GmbH**

Rupert-Mayer-Straße 46  
D - 81379 München  
Germany

Hotline 08001827699  
info.de@sweden-martina.com

**Sweden & Martina Inc.**

DCI Management  
301 Pleasant Street  
Abbottstown, 17301 PA, US

Toll free (844)8MARTINA/844.862.7846  
info.us@sweden-martina.com

The implants, standard prosthetic components and surgical instruments contained in this catalogue are Medical Devices and are manufactured by Sweden & Martina S.p.A. They are conform to the ISO 9001 and ISO 13485 standards and are certified with the CE Mark (Class I) and CE 0476 mark (Class IIA and class IIB) in compliance with European Medical Device Directive No. 93/42 and European Directive No. 2007/47/CE. They are conform to the QSR 21 CFR part 820 and are approved by FDA. We have met the good manufacturing standards (GMP) set forth by many countries worldwide, including the United States FDA.



All trademarks herein are the property of Sweden & Martina S.p.A. unless otherwise indicated.  
This material is intended for laboratories and clinicians and is not intended for patient distribution.  
This material is not to be redistributed, duplicated, or disclosed without the express written consent of Sweden & Martina S.p.A.  
For additional product information, including indications, contraindications, warnings, precautions, and potential adverse effects, see Sweden & Martina S.p.A. website.

The contents are updated at the time of publication. Check with the company for any subsequent updates.