



M.blue plus[®]

THE BALANCED WAY OF LIFE
INSPIRED BY YOU

EN Instructions for use |

 www.miethke.com

US This Instructions for Use is NOT intended for United States users. Please discard.
The Instructions for Use for United States users can be obtained by visiting our website at www.aesculapusa.com. If you wish to obtain a paper copy of the Instructions for Use, you may request one by contacting your local Aesculap representative or Aesculap's customer service at 1-800-282-9000. A paper copy will be provided to you upon request at no additional cost.

CONTENTS

1	PREFACE AND IMPORTANT INFORMATION	4
2	INFORMATION ON HANDLING THESE INSTRUCTIONS FOR USE	4
2.1	EXPLANATION OF THE WARNINGS	4
2.2	DISPLAY CONVENTIONS	4
2.3	OTHER ACCOMPANYING DOCUMENTS AND ADDITIONAL INFORMATION	4
2.4	FEEDBACK ON THE INSTRUCTIONS FOR USE	5
2.5	COPYRIGHT, DISCLAIMER, WARRANTY AND OTHER INFORMATION	5
3	DESCRIPTION <i>M.blue plus</i>	5
3.1	MEDICAL PURPOSE	5
3.2	CLINICAL BENEFITS	5
3.3	INDICATIONS	5
3.4	CONTRAINDICATIONS	5
3.5	INTENDED PATIENT GROUPS	5
3.6	INTENDED USERS	5
3.7	INTENDED USE ENVIRONMENT	5
3.8	TECHNICAL DESCRIPTION	6
3.9	FUNCTIONING OF THE VALVE SYSTEM	6
3.10	SELECTION OF THE APPROPRIATE PRESSURE SETTING	7
3.11	PRESSURE-FLOW CHARACTERISTICS	8
3.12	PRESSURE LEVEL IDENTIFICATION IN X-RAY IMAGES	8
3.13	APPLICATION OF THE <i>M.blue plus Instruments</i>	10
3.14	SYSTEM COMPONENTS	14
3.15	FUNCTIONAL SAFETY AND COMPATIBILITY WITH DIAGNOSTIC PROCEDURES	14
3.16	SUMMARY OF SAFETY AND CLINICAL PERFORMANCE	15
4	PROPERTIES <i>M.blue plus</i>	15
4.1	PRODUCT DESCRIPTION	15
4.2	IMPORTANT SAFETY INFORMATION	15
4.3	PATIENT EDUCATION	16
4.4	TRANSPORT AND STORAGE	16
4.5	USE OF THE PRODUCT	16
4.6	EXPLANATION AND DISPOSAL	19
4.7	TECHNICAL INFORMATION	19
4.8	SYMBOLS USED FOR LABELLING	20
5	MEDICAL DEVICE CONSULTANTS	20

1 PREFACE AND IMPORTANT INFORMATION

Preface

Thank you for purchasing the medical device *M.blue plus*. Please contact us if you have any questions about the contents of these instructions for use or the use of the product.

Your team at Christoph Miethke GmbH & Co. KG

Relevance of the instructions for use



WARNING

Improper handling and non-intended use of this product can cause risks and damages. Therefore, please read and closely follow these instructions for use. Always keep them to hand. Follow the safety instructions to avoid personal injury or material damage.

Scope

M.blue plus includes the following components:

- ▶ *M.blue plus*

Additional options:

- ▶ *Reservoirs*
(including paediatric versions)
- ▶ *Prechambers*
(including paediatric versions)
- ▶ *Burrhole Deflector*
(including paediatric version)
- ▶ *Ventricular Catheter* with stylet
- ▶ *Peritoneal Catheter*

Basic UDI-DI

4041906653-MSHUNTS-0002CM

2 INFORMATION ON HANDLING THESE INSTRUCTIONS FOR USE

2.1 EXPLANATION OF THE WARNINGS



DANGER

Indicates an imminently hazardous situation which, if not avoided, will result in death or serious injury.



WARNING

Indicates a potentially hazardous situation which, if not avoided, could result in death or serious injury.



CAUTION

Indicates a potentially hazardous situation which, if not avoided, could result in minor or moderate injury.



NOTICE

Indicates information considered important, but not hazard-related (e.g. messages relating to property damage).

The symbols for danger, warning and caution are yellow warning triangles with a black edge and a black exclamation mark.

2.2 DISPLAY CONVENTIONS

Display	Description
<i>Italics</i>	Indicates <i>product names</i>

2.3 OTHER ACCOMPANYING DOCUMENTS AND ADDITIONAL INFORMATION

These instructions for use as well as translations into additional languages can be found on our website:

<https://www.miethke.com/downloads/>

The delivery includes a Patient Implant Card (IC) with IC label containing product information. The respective healthcare facility must record the information about the patient, the implant as well as the doctor in charge on the IC, and the IC label must be attached. The Patient Implant Card is thus intended to make all of the important information available to the patient in a compact form. This website also contains information about the symbols used on the Patient Implant Card together with a description on how the Patient Implant Card is to be completed by the healthcare institution.

Patient labels containing information about the product are enclosed with the delivery. The patient labels provide the treating physician with all the product information in a compact form for the patient record. For individually purchased shunt components, the patient label must be added to the existing Implant Card.

Helpful information for patients, particularly concerning the symbols on the Implant Card and the labels, is available on this website:

<https://www.miethke.com/ic/>

If you still need additional information despite carefully reading the instructions for use and

the additional information, please contact us or your authorised distributor.

2.4 FEEDBACK ON THE INSTRUCTIONS FOR USE

Your opinion is important to us. Please let us know if you have any requests and criticisms about these instructions for use. We will analyse your feedback and take it into account for the next version of the instructions for use where appropriate.

2.5 COPYRIGHT, DISCLAIMER, WARRANTY AND OTHER INFORMATION

Christoph Miethke GmbH & Co. KG guarantees a faultless product that is free of material and manufacturing defects upon delivery.

No liability, guarantee or warranty for safety and functionality can be assumed if the product is modified in any way other than described in this document, if it is combined with products by another manufacturer or if it is used in any way other than for the intended purpose and the intended use.

Christoph Miethke GmbH & Co. KG points out that the reference to its trademark rights applies solely to jurisdictions in which it has trademark rights.

3 DESCRIPTION *M.blue plus*

3.1 MEDICAL PURPOSE

The product *M.blue plus* is intended for shunting of cerebrospinal fluid (CSF).

3.2 CLINICAL BENEFITS

The clinical benefit of the MIETHKE shunt component *M.blue plus* as part of a shunt system is improvement of symptoms in the hydrocephalus therapy.

3.3 INDICATIONS

The following indications apply to *M.blue plus*:

- ▶ Treatment of hydrocephalus

3.4 CONTRAINDICATIONS

The following contraindications apply to *M.blue plus*:

- ▶ Infections in the implantation area
- ▶ Pathological concentrations levels (e.g. of blood components and/or protein) within the cerebrospinal fluid
- ▶ Intolerance to materials of the shunt system

3.5 INTENDED PATIENT GROUPS

- ▶ Patients who are treated with a CSF shunt system on account of their clinical picture

3.6 INTENDED USERS

In order to avoid risks due to false diagnoses, incorrect treatments and delays, the product must only be used by users with the following qualifications:

- ▶ Medical professionals, e. g. neurosurgeons
- ▶ Knowledge of mode of operation and intended use of the product
- ▶ Successful participation in product training

3.7 INTENDED USE ENVIRONMENT

Professional Healthcare Facilities

- ▶ Implantation under sterile operating theatre conditions

3.8 TECHNICAL DESCRIPTION

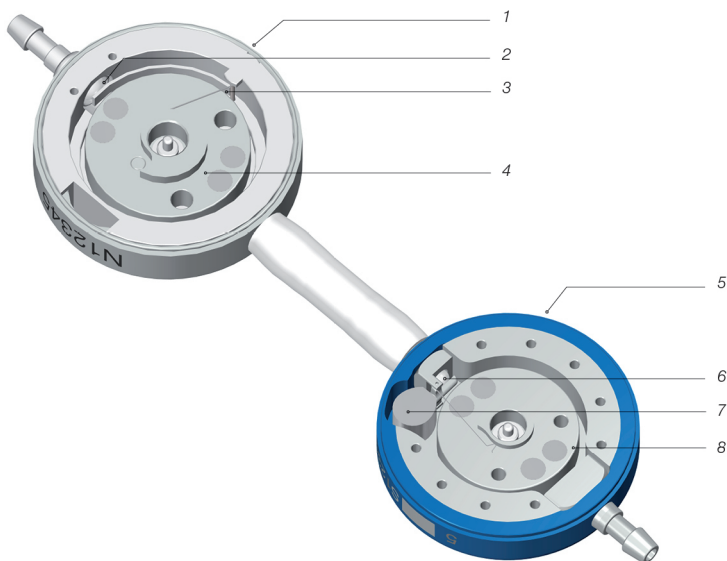

Fig. 1: M.blue plus cross section

1. Adjustable differential pressure unit

2. Sapphire ball
3. Torsion spring
4. Rotor

5. Adjustable gravitational unit

6. Sapphire ball
7. Tantalum weight
8. Rotor

The *M.blue plus* is a valve system made of titanium. It consists of an adjustable differential pressure unit (hereinafter also *proGAV 2.0*) and an adjustable Gravitational Unit (hereinafter also *M.blue*) (Fig. 1).

The adjustable differential pressure unit (1) in the proximal part of the valve system consists of a stable titanium housing with an integrated ball-cone valve (2) in the front section. A torsion spring (3) determines the opening pressure of this unit. The pretension of the spring, and thus the valve opening pressure, can be adjusted post-surgically through the skin using a pivoted rotor (4).

The adjustable gravitational unit (5) contains a tantalum weight (7), which holds a sapphire ball in the ball seat via a lever (6). Depending on the patient's body position, the influence of the tantalum weight on the sapphire ball changes, which also affects the valve opening pressure.

Via a rotor (8), the pretension of the torsion spring connected to the lever can be adjusted through the skin after surgery. This way, the impact of the tantalum weight on the sapphire ball can be influenced and, consequently, the valve opening pressure can be adjusted.

3.9 FUNCTIONING OF THE VALVE SYSTEM

The *M.blue plus* is a posture-dependent hydrocephalus valve system. The opening pressure of the *M.blue plus* is composed of the opening pressures of the adjustable differential pressure unit and the adjustable gravitational unit.

Horizontal body position

In the horizontal position, the gravitational unit is always open and does not present any resistance.

The opening pressure of the *M.blue plus* in the horizontal position is thus determined by the adjustable differential pressure unit. The basic operating principle of the differential pressure unit is shown in Fig. 2 a) and b).

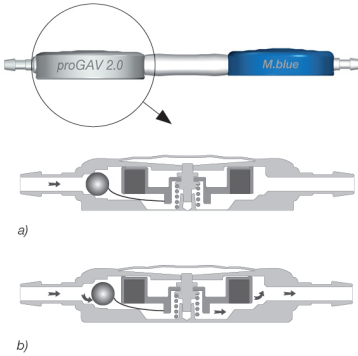

Fig. 2: Functional principle of the differential pressure unit

a) closed b) open

In Fig. 2 a), the valve is closed; hence, shunting is not possible.

If the patient's intraventricular pressure (IVP) exceeds the spring force of the torsion spring, which otherwise keeps the differential pressure unit closed, the sealing ball moves out of the cone, leaving a gap for CSF shunting (Fig. 2 b).

Vertical body position

As the patient sits or stands up, the Gravitational Unit closes the discharge channel in the proximal part of the valve (Fig. 3 a).

Thus, the opening pressure of the *M.blue plus* is increased in the upright position, because now the weight of the tantalum weight (opening pressure of the Gravitational Unit) must be overcome in addition to the opening pressure of the differential pressure unit. Shunting is only possible again when the sum of IVP and hydrostatic suction is greater than the opening pressure of both units (Fig. 3 b).

For individual adaptation of the opening pressure to the patient, an opening pressure between 0 and 20 cmH₂O can be selected for the adjustable differential pressure unit, and additionally a valve opening pressure between

0 and 40 cmH₂O can be selected for the adjustable gravitational unit.

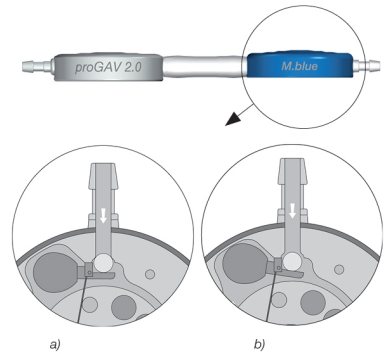

Fig. 3: Gravitational unit in the vertical body position
a) closed b) open



CAUTION

During physical activity associated with shock (e.g. jogging), the opening pressure of the *M.blue plus* may decrease temporarily according to laboratory results. Fundamentally, though, functionality remains the same. At the end of physical activity, the opening pressure returns to its original level and remains stable.

3.10 SELECTION OF THE APPROPRIATE PRESSURE SETTING

Recommended pressure settings for the *M.blue plus* are available at:

<https://www.miethke.com/downloads/>

This is a non-binding recommendation for the treating physician. The physician decides on each case independently, individually and autonomously in accordance with his/her diagnosis.

The adjustable differential pressure unit of the *M.blue plus* is set to a pressure level of 5 cmH₂O upon delivery.

The adjustable Gravitational Unit of the *M.blue plus* is set to a pressure level of 20 cmH₂O upon delivery.

By changing the pressure level, this pre-set opening pressure can be changed to a different pressure prior to implantation.

Horizontal body position

The opening pressure in the horizontal body position is determined by the pressure level of the differential pressure unit.

In this case, the pressure level should be set in accordance with the patient's clinical picture, indication and age. The standard settings for the horizontal position are 5 to 10 cmH₂O.

Vertical body position

The opening pressure of the *M.blue plus* for the vertical body position is calculated from the sum of the pressure levels of the differential pressure unit and the Gravitational Unit.

Patient height, activity level and potentially increased abdominal pressure (obesity) should be taken into account in selecting the opening pressure level for the gravitational unit.

3.11 PRESSURE-FLOW CHARACTERISTICS

A flow rate of 5 to 50 ml/h causes the following pressure-flow characteristics. The pressure level at the reference flow rate of 20 ml/h is highlighted in bold. The reference flow rate is highlighted by a dotted line (----). Note that testing the product may provide different results depending on the test setup.

The valve design allows continuously variable adjustment (shown by double arrows: ↔) between the illustrated pressure values to find the individual pressure setting for each patient. The combination with catheters (inner diameter > 1 mm) does not fundamentally affect the pressure-flow characteristics.

Horizontal body position

The opening pressure in the horizontal body position is determined by the selected pressure level of the differential pressure unit. The pressure flow characteristics for the continuously variable differential pressure unit in the horizontal body position are shown as an example for pressure levels 0, 10 and 20 cmH₂O:

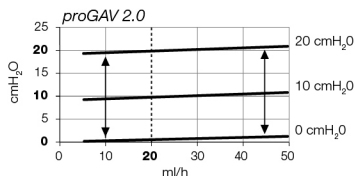

Fig. 4: Adjustable horizontal differential pressure unit; Pressure (cmH₂O), flow rate (ml/h)
Tolerances: ±4 cmH₂O

Vertical body position

In the vertical body position, the *M.blue plus* opening pressure is composed of the different settings of the continuously variable differential pressure unit (*proGAV 2.0*) and the continuously variable Gravitational Unit (*M.blue 0*) (Fig. 4 + Fig. 5).

Below are examples of the pressure-flow characteristics for pressure level settings of *M.blue 0* (0, 20 and 40 cmH₂O) in the vertical body position. Only values of the adjustable Gravitational Unit are shown without consideration of the adjustable differential pressure unit:

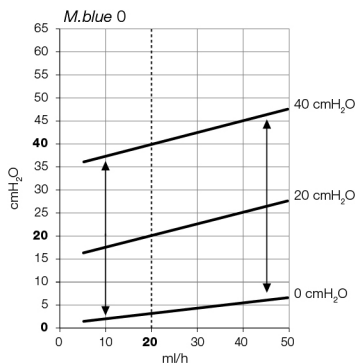

Fig. 5: Adjustable vertical gravitational unit; pressure (cmH₂O), flow rate (ml/h)
Tolerance: ±8 cmH₂O

3.12 PRESSURE LEVEL IDENTIFICATION IN X-RAY IMAGES

proGAV 2.0 differential pressure unit

The selected pressure level of the *M.blue plus* differential pressure unit should always be monitored using the *proGAV 2.0 Compass* or the

M.blue plus Compass, but it can also be checked with the aid of an X-ray image (Fig. 6).

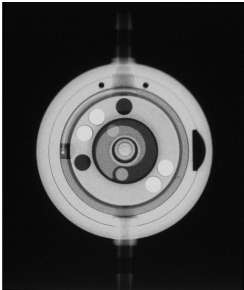

Fig. 6: X-ray image (proGAV 2.0 adjustable differential pressure unit, set to 14 cmH₂O)

The rotor setting is decisive in this case. The four magnets in the rotor appear in the X-ray image as white dots and are located opposite each other in pairs. On one side of the rotor, two additional burr holes (right and left next to the magnet pairs) serve as orientation. They appear as black dots in the X-ray image. This side can be described as the rear side of the rotor. The two front magnets are on the opposite side.

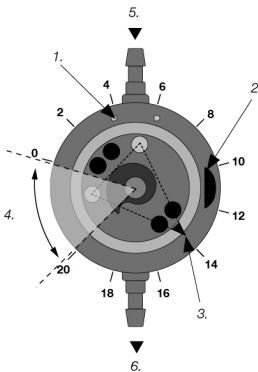

Fig. 7: Schematic representation of rotor in an X-ray image

1. Admittance markings, 2. Valve marking
3. Triangle apex, 4. Non-adjustable range
5. proximal, 6. distal

The space between these two magnets can be considered as the apex of the triangle. The pressure level can be read off using the orientation of this intermediate space (Fig. 7). The apex of the triangle can take up any position except the space marked as a the non-

adjustable range in Fig. 7. The opening pressure of the proGAV 2.0 can thus be infinitely variably adjusted from 0 up to 20 cmH₂O.

To prevent reading the pressure level in reverse, the valve is fitted with a valve marking on one side, which appears black in the X-ray image – in a top view onto the implanted valve as in Fig. 6, the recess is visible on the right-hand side.

M.blue gravitational unit

The selected pressure level of the M.blue gravitational unit should always be monitored using the M.blue plus Compass, but it can also be checked using X-ray (Fig. 8).

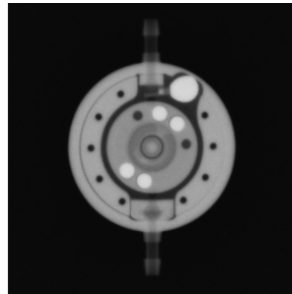

Fig. 8: X-ray image (adjustable gravitational unit pre-set to 20 cmH₂O; differential pressure unit: 0 cmH₂O)

The rotor setting is decisive in this case. The four magnets in the rotor appear in the X-ray image as white dots and are located opposite each other in pairs. On one side of the rotor, two additional burr holes (right and left next to the magnet pairs) serve as orientation. They appear as black dots in the X-ray image. This side can be described as the rear side of the rotor. The two front magnets are on the opposite side.

The space between these two magnets can be considered as the apex of the triangle. The pressure level can be read off using the orientation of this intermediate space (Fig. 9). The apex of the triangle can take up any position except the space marked as a the non-adjustable range in Fig. 9. This means that the opening pressure of the M.blue can be infinitely variably adjusted from 0 up to 40 cmH₂O. To prevent reading the pressure level in reverse, the top view of the valve shows an obvious recess in the housing ring with the tantalum weight to the right of the inlet connector (Fig. 8).

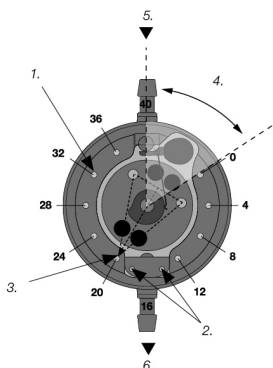

Fig. 9: Schematic representation of rotor in an X-ray image

1. Coding holes for the adjustable gravitational unit
2. Coding holes for the differential pressure unit
3. Triangle apex, 4. Non-adjustable range
5. proximal, 6. distal

3.13 APPLICATION OF THE M.blue plus Instruments



WARNING

Because of the magnets inside the *M.blue plus Instruments*, *M.blue plus Instruments* must not be used in the vicinity of active implants that are influenced by magnetism, such as cardiac pacemakers. When adjusting with the *M.blue plus Instruments*, the safety distance specified by the manufacturer of the active implant should be observed.



CAUTION

- ▶ The *M.blue plus Instruments* must not be taken into a MRI facility as this may pose a safety risk to the patient and/or the user.
- ▶ Only *M.blue plus Instruments* approved for that purpose must be used to determine, change and monitor the opening pressure of the gravitational unit of the *M.blue*.
- ▶ The opening pressure of the differential pressure unit (*proGAV 2.0*) can be determined, changed and monitored with the *M.blue plus Instruments* or with the *proGAV 2.0 Tools* approved for that purpose.



NOTICE

The *M.blue plus Adjustment Ring* emits a magnetic field. Metallic objects and magnetic storage media should be placed at a sufficient safety distance.

The *M.blue plus Instruments* may only be used by trained specialists.

The selected pressure level of the *M.blue plus* can be determined, adjusted and monitored using the *M.blue plus Instruments*.

The *M.blue plus Compass* (Fig. 10) is used for localising and reading the adjustable gravitational unit of (*M.blue*) as well as the adjustable differential pressure unit (*proGAV 2.0*) of the *M.blue plus*.

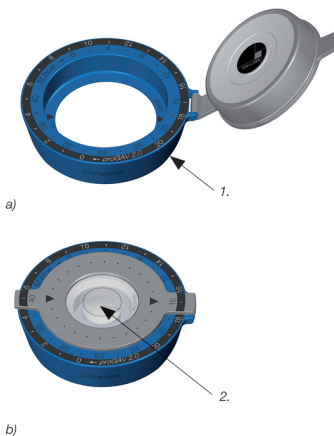

Fig. 10: *M.blue plus Compass*

- a) open, 1. scale ring
- b) closed, 2. float gauge compass

The *M.blue plus Adjustment Ring* (Fig. 11) is used to set the opening pressure of the gravitational unit of the *M.blue* from 0 to 40 cmH₂O. The *M.blue plus Adjustment Ring* can also be used to set the opening pressure of the differential pressure unit of the *proGAV 2.0* from 0 to 20 cmH₂O.



Fig. 11: *M.blue plus Adjustment Ring*

The opening pressure of the adjustable gravitational unit of the *M.blue* can be changed before or after implantation. It is pre-set by the manufacturer to 20 cmH₂O.

The opening pressure of the adjustable differential pressure unit of the *proGAV 2.0* can be

changed before or after implantation. It is pre-set by the manufacturer to 5 cmH₂O.

In order to set the opening pressures, the following steps must be performed:

1. Localisation



CAUTION

- ▶ **The *M.blue plus* Compass reacts sensitively to external magnetic fields. In order to rule out unwanted interactions, the *M.blue plus* Adjustment Ring should not be placed in the immediate vicinity of the *M.blue plus* Compass when determining the opening pressure. We recommend a minimum distance of 30 cm.**
- ▶ **Swelling of the skin may make adjustment difficult for a few days after surgery. If the valve setting cannot be checked conclusively using the *M.blue plus* Compass, we recommend checking it with an imaging method.**
- ▶ **The *M.blue plus* Compass should be placed as centrally as possible over the valve, as the determined opening pressure may otherwise be incorrect.**
- ▶ **Possible air pockets in the *M.blue plus* Compass do not affect the compass function.**

When the *M.blue plus* Compass is opened, a circular cut-out becomes visible, which is used to localise the valve in the patient's head as centrally as possible using the index finger (Fig. 12).



Fig. 12: Localising the valve

The direction markings show the flow direction.

2. Verification procedure

In order to determine the selected pressure level, the *M.blue plus* Compass is then closed

again. The float gauge should now be centred by moving the instrument within the designated circular marking (Fig. 13). Once the float gauge is centred, the current setting of the opening pressure of the differential pressure unit (*proGAV 2.0*) or the gravitational unit (*M.blue*) can be read from the line marking on the float gauge (Fig. 13).

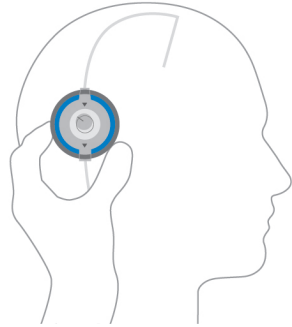

Fig. 13: Determining the pressure setting with the *M.blue plus* Compass

There are two scales on the scale ring (Fig. 14). The grey adjustment range from 0 to 20 cmH₂O on the outer scale applies to the opening pressure of the adjustable differential pressure unit of the *proGAV 2.0*.

The blue adjustment range from 0 to 40 cmH₂O on the inner scale applies to the opening pressure of the gravitational unit of the *M.blue*.

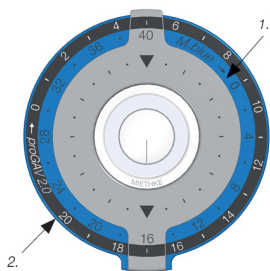

Fig. 14: Scale ring of the M.blue plus Compass

1. Inner: Scale for the M.blue gravitational unit from 0 to 40 cmH₂O (the opening pressure of the M.blue gravitational unit in the illustrated example is 16 cmH₂O)
2. Outer: Scale for the proGAV 2.0 differential pressure unit from 0 to 20 cmH₂O (the opening pressure of the proGAV 2.0 differential pressure unit in the illustrated example is 17 cmH₂O)

3. Adjustment process



CAUTION

When adjusting the gravitational unit of the M.blue, care must be taken to change the opening pressure by a maximum of 16 cmH₂O per adjustment process; otherwise, errors can result.

Example: The opening pressure is to be changed from 6 to 36 cmH₂O. The correct method is an adjustment in two stages: an initial adjustment from 6 to 22 cmH₂O and subsequently from 22 to 36 cmH₂O.



CAUTION

When adjusting the differential pressure unit of the proGAV 2.0, care must be taken to change the opening pressure by a maximum of 8 cmH₂O per adjustment process; otherwise, errors can result.

Example: The opening pressure is to be changed from 3 to 18 cmH₂O. The correct method is an adjustment in two stages: an initial adjustment from 3 to 11 cmH₂O and subsequently from 11 to 18 cmH₂O.

3a. Adjustment using the M.blue plus Adjustment Ring

In order to adjust the opening pressure, the M.blue plus Compass is opened, but without changing the position of the scale ring. The M.blue plus Adjustment Ring is now inserted into the scale ring in such a manner that the line marking points to the desired value on the scale of the scale ring (Fig. 15).

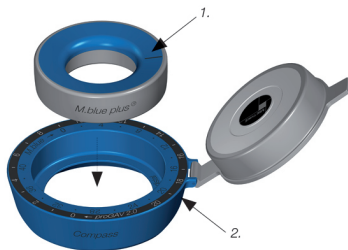

Fig. 15: Inserting the M.blue plus Adjustment Ring
1. M.blue plus Adjustment Ring, 2. scale ring

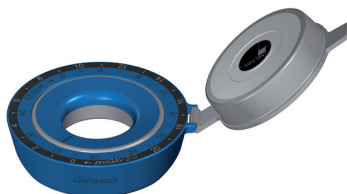

Fig. 16: The example illustrates setting the proGAV 2.0 differential pressure unit to 1 cmH₂O or setting the M.blue gravitational unit to 32 cmH₂O.

By applying slight pressure with the index finger to the valve diaphragm located in the centre of the M.blue plus Adjustment Ring and under the skin, the rotor brake is released and the opening pressure of the gravitational unit is changed to the desired value (Fig. 17).

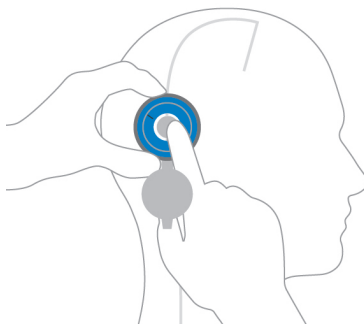

Fig. 17: Adjustment using the M.blue plus Adjustment Ring

Both the differential pressure unit proGAV 2.0 and the gravitational unit M.blue are equipped with a feedback mechanism.

Due to the valve housing design, targeted pressure on the valve produces an audible acoustic signal (a clicking sound) and/or palpable resistance as soon as the rotor brake has been released. The valve thus shows both acoustically and haptically when the pressure is sufficient for uncoupling. Once this pressure has been released, the rotor is once again adjustment-proof. Although the click caused by releasing the rotor brake is easily audible before implantation, it may be considerably reduced after implantation and the filling of the valve depending on its position and the condition of the implant surroundings. Normally, however, it should be audible to the patient or by using a stethoscope.

3b. Adjustment using the M.blue plus Adjustment Assistant

Alternatively, the *M.blue plus Adjustment Assistant* can be used to adjust the opening pressure. To do this, insert the *M.blue plus Adjustment Assistant* into the *M.blue plus Adjustment Ring* aligned to the desired value and press it with your index finger (Fig. 18).

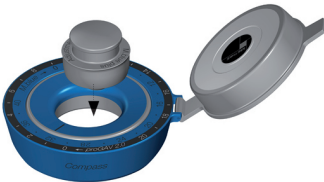

Fig. 18: *M.blue plus Adjustment Assistant*

4. Checking after adjustment

After adjusting the valve opening pressure, it is recommended to check the set pressure level. To do this, proceed as in Points 1 and 2. Should the measured value not correspond with the required pressure level, the adjustment process should be repeated. To do this, start again at Point 3.

5a. Check and adjustment using the M.blue Checkmate

The *M.blue Checkmate* (Fig. 19) is supplied sterile and can be re-sterilised. The *M.blue Checkmate* can be used to change and check the pressure level before and during valve implantation directly at the *M.blue*. To deter-

mine the pressure level, the *M.blue Checkmate* is placed centrally onto the *M.blue*. The *M.blue Checkmate* automatically aligns itself over the valve. The pressure level can be read from the direction of the proximal catheter (leading towards the valve). If the pressure level is to be adjusted, the *M.blue Checkmate* is placed centrally onto the *M.blue*. When doing so, the required pressure level must point towards the proximal catheter (leading towards the valve). By slightly pressing the *M.blue Checkmate* onto the valve, the rotor brake in the *M.blue* is released and the pressure level set.



Fig. 19: *M.blue Checkmate*, colour: blue
Pressure levels: 0 to 40 cmH₂O

5b. Check and adjustment using the proGAV Checkmate

The *proGAV Checkmate* (Fig. 20) is supplied sterile and can be re-sterilised. This makes it possible to carry out a pressure level change and the check during valve implantation directly on the adjustable differential pressure unit. To determine the pressure level, the *proGAV Checkmate* is centred over the adjustable differential pressure unit. The *proGAV Checkmate* automatically aligns itself over the valve. The pressure level can be read off towards the proximal catheter (leading to the ventricle). To adjust the pressure level, the *proGAV Checkmate* is centred over the adjustable differential pressure unit. When doing so, the required pressure level must point towards the proximal catheter (leading to the ventricle). By slightly pressing the *proGAV Checkmate* onto the valve, the adjustable differential pressure unit brake is released and the pressure level is set.



Fig. 20: proGAV Checkmate
Pressure levels: 0 to 20 cmH₂O

3.14 SYSTEM COMPONENTS

Combination with shunt components

The *M.blue plus* can be safely combined with our range of implantable shunt components. We recommend using the Christoph Miethke GmbH & Co. KG products in combination with *M.blue plus*.

Reservoirs

The use of shunt systems with a reservoir makes it possible to puncture the reservoir and check the shunt function.

Any puncture of the reservoir should be performed perpendicular to the reservoir surface with a sharp cannula of max. Ø 0.9 mm. The silicone membrane can be punctured 30 times without any restrictions. A stable titanium base prevents the base from being pierced.

An integrated check valve in the *SPRUNG RESERVOIR* and the *CONTROL RESERVOIR* pumps the cerebrospinal fluid towards the valve, thus making it possible to check the distal part of the shunting system (reservoir difficult to squeeze out) as well as the *Ventricular Catheter* (reservoir fills very slowly after squeezing out). The volume per pump cycle is approx. 0.2 ml for the normal reservoirs and approx. 0.1 ml for the paediatric reservoirs with check valve.

During pumping, access to the *Ventricular Catheter* is closed. The use of a reservoir does not change the opening pressure of the shunt system.



CAUTION

Frequent pumping of the Reservoir can result in excessive shunting and thus lead to pressure conditions outside the normal physiological range. The patient should be properly informed about this risk.

Burrhole Deflector

Because of the tight fit on the *Ventricular Catheter*, the *Burrhole Deflector* makes it possible to choose the length of catheter penetrating into the skull prior to implantation. The *Ventricular Catheter* is deflected at a right angle in the burr hole (see chapter 4.5.5).

Tube systems

The *M.blue plus* can be ordered as an individual valve unit or as a shunt system with integrated catheters (internal diameter 1.2 mm, external diameter 2.5 mm). These catheters are designed for MIETHKE valves or MIETHKE shunt components with a connector outer diameter of 1.9 mm.

The catheters are made from silicone and contain barium sulphate. This ensures that the X-ray image is clearly visible.

For a new connection of catheters and connectors, the catheters must be carefully secured with a ligature to the valve's connectors or shunt components.

3.15 FUNCTIONAL SAFETY AND COMPATIBILITY WITH DIAGNOSTIC PROCEDURES

- ▶ *M.blue plus* together with the entire shunt system can safely withstand pressure of up to 100 cmH₂O occurring during and after surgery.
- ▶ Nuclear magnetic resonance (MRI) examinations up to a field strength of 3 Tesla or computed tomography (CT) examinations can be performed without danger or impairment to the valve function. The *M.blue plus* is MR Conditional. The *Catheters* are MR Safe. *Reservoirs*, *Prechambers*, *Burrhole Deflectors* and *Titanium Connectors* are MR Conditional. The stylet is MR Unsafe.



CAUTION

In MRI imaging *M.blue plus* creates artefacts that are larger than the valve itself.

The conditions for MRI security of the products are found on our website:
<https://miethke.com/downloads/>

3.16 SUMMARY OF SAFETY AND CLINICAL PERFORMANCE

The summary of safety and clinical performance (SSCP) can be downloaded from the following address:

<https://www.miethke.com/downloads/>

4 PROPERTIES M.blue plus

4.1 PRODUCT DESCRIPTION

4.1.1 M.blue plus VARIANTS

The *M.blue plus* has an adjustable differential pressure unit and an adjustable gravitational unit.

Adjustable differential pressure unit	Adjustable gravitational unit
0–20 cmH ₂ O	0–40 cmH ₂ O

The *M.blue plus* is also available as a shunt system and can come with the following components: *Ventricular Catheter, Peritoneal Catheter, Prechambers, Reservoirs.*

4.1.2 SCOPE OF DELIVERY

Box content	Number
<i>M.blue plus</i> Shunt system sterile packaging	1
Instructions for use for <i>M.blue plus</i>	1
Patient Implant Card (IC)	1
IC label	6
Patient label	6
Insert regarding the Patient Implant Card	1
Pressure level recommendation	1

4.1.3 STERILITY



WARNING

The products must not be used if the packaging or the product is damaged or after the expiry date.

The products are sterilised with steam under strictly controlled conditions. The respective expiry date is printed on the packaging.

4.1.4 REPEATED USE AND RESTERILISATION



WARNING

The product must not be resterilised or reprocessed in any other way as the safe functioning and sterility of the product cannot be guaranteed.

Products that have already been implanted in a patient must not be reused either on the same or a different patient in order to minimise the risk of infection.

4.1.5 PRODUCT LIFETIME

The technical lifetime of the medical device *M.blue plus* is 15 years. Patient-specific circumstances or known side effects such as biological deposits or infection can shorten the lifetime and make revision necessary. In a favorable case, the real lifetime can also exceed the expected time span.

4.1.6 SINGLE-USE PRODUCT

This product is intended for single use. Reprocessing may lead to significant changes to the properties of the *M.blue plus*. No guarantee can be assumed for the functional safety of resterilised products.

4.1.7 PRODUCT CONFORMITY

The product meets current regulatory requirements.

The requirements stipulate the comprehensive documentation of the whereabouts of medical devices used in humans. The individual identification number of the medical device should therefore be recorded in the patient's medical records to ensure complete traceability.

4.2 IMPORTANT SAFETY INFORMATION

4.2.1 SAFETY INSTRUCTIONS

Important! Read all safety instructions carefully before using the product. Follow the safety instructions in order to avoid injuries and life-threatening situations.



WARNING

► **The products must not be used if the packaging or the product is damaged or after the expiry date.**

**WARNING**

- ▶ **Due to the risk of injury resulting from incorrect use of the product, the instructions for use must be carefully read and understood before the product is used for the first time.**
- ▶ **Prior to use, it is essential to check the product for completeness and integrity.**

4.2.2 COMPLICATIONS, SIDE EFFECTS, PRECAUTIONS AND RESIDUAL RISKS

The following complications can occur in conjunction with the *M.blue plus*:

- ▶ Headaches, dizzy spells, mental confusion, vomiting in cases of possible leakage from the shunt system and shunt dysfunction
- ▶ Redness/irritation of the skin and tightness around the implantation site as an indication of a possible infection at the implant
- ▶ Occlusions caused by protein and/or blood components in the cerebrospinal fluid
- ▶ Overdrainage/underdrainage
- ▶ Noise development
- ▶ Allergic reaction / intolerance to product materials

Violent external shocks (accident, fall etc.) may put the integrity of the shunt system at risk.

As a precaution, a physician must be consulted immediately if the patient suffers from skin rashes and tightness, severe headaches, dizzy spells or similar.

The following residual risks exist when using the *M.blue plus*:

- ▶ Persistent headache
- ▶ Severe infection (e.g. sepsis, meningitis) / allergic shock
- ▶ Acute and chronic hygroma/subdural haematoma
- ▶ Cerebrospinal fluid accumulations
- ▶ Tissue damage/puncture
- ▶ Skin irritation
- ▶ Local shunt irritation /allergic reaction

4.2.3 REPORTING OBLIGATION

All serious incidents (damage, injuries, infections, etc.) occurring in relation to the product

must be reported to the manufacturer and the responsible state authority.

4.3 PATIENT EDUCATION

The attending physician is responsible for informing the patient and/or his/her proxy in advance. The patient is to be informed about warnings, precautions, contraindications, precautionary measures to be taken as well as restrictions on use in relation to the product. (Ch. 4.1.5, 4.2, 4.5, 4.7).

4.4 TRANSPORT AND STORAGE

The medical devices must always be transported and stored in a clean and dry place.

4.4.1 TRANSPORT

Transport conditions

Temperature range for transport	-30 °C ... +40 °C
--	-------------------

4.4.2 STORAGE

Storage conditions

Temperature range for storage	room temperature
--------------------------------------	------------------

4.5 USE OF THE PRODUCT

4.5.1 INTRODUCTION

The *M.blue plus* is a posture-dependent valve system with an adjustable gravitational unit and an adjustable differential pressure unit.

The *M.blue plus* is used for shunting cerebrospinal fluid (CSF) into the peritoneum in the treatment of hydrocephalus. Valves and Reservoirs are placed in suitable positions along the course of the shunt.

4.5.2 SAFETY NOTICES AND WARNINGS

**WARNING**

- ▶ **The correct flow direction must be strictly observed as per the arrows. Incorrect implantation will result in flow prevention and underdrainage.**
- ▶ **The gravitational unit of the *M.blue plus* is posture-dependent. For that reason, care must be taken to implant the gravitational unit (*M.blue*) parallel to the body axis.**

**WARNING**

- ▶ The adjustable MIETHKE valve should not be implanted in an area that makes the detection or palpation of the valve difficult (e. g. underneath heavily scarred tissue).
- ▶ During placement, it must be ensured that adjustable MIETHKE valves are positioned a maximum of 10 mm below the skin surface to make it easier to locate the valve as well as to read and adjust the valve pressure level. If the implantation site is unfavourably chosen or the skin above the valve is too thick (skin and tissue thickness greater than 10 mm), it may no longer be possible to locate the valve as well as read and adjust the valve pressure level. The valve then works with a fixed pressure level.
- ▶ Silicone is extremely electrostatic. Care must be taken to avoid the catheters coming into contact with dry cloths, talcum powder or rough surfaces. Clinging particles could lead to tissue reactions.
- ▶ When using sharp instruments, care should be taken to avoid cuts and scratches in the silicone elastomer.
- ▶ It must be ensured that the ligature is not tightened excessively. Damage may result in a loss of integrity of the shunt and thus necessitate a revision.
- ▶ The catheters should only be blocked with an atraumatic clamp and not directly behind the shunt component (e.g. valve, reservoir or connector) as they might be damaged otherwise.

**CAUTION**

- ▶ Frequent pumping of the Reservoir can result in excessive shunting and thus lead to pressure conditions outside the normal physiological range. The patient should be properly informed about this risk.
- ▶ If a magnetic field is being applied and pressure is applied to the valve at the same time, thus triggering the brake mechanism, and adjustment of the valve cannot be ruled out.
- ▶ In MRI imaging *M.blue plus* creates artefacts that are larger than the valve itself.

4.5.3 REQUIRED MATERIALS

The *M.blue plus* is designed so that it can be safely used with the shunt components described in chapter 3.14.

Catheters with an inner diameter of 1.2 mm and an outer diameter of 2.5 mm should be used for connection. In any case, catheters have to be carefully secured with a ligature to the con-

nectors of the shunt components. Any kinks in the catheter must be avoided.

4.5.4 PREPARING FOR IMPLANTATION**Checking the sterile packaging**

Immediately before using the product, the sterile packaging must be visually inspected in order to check the integrity of the sterile barrier system. The products should only be removed from the packaging immediately prior to use.

Preoperative valve test

The *M.blue plus* should be vented before implantation and checked for permeability. The most careful way of filling the valve is by aspiration through a sterile single-use syringe attached to the distal end of the catheter. The distal end of the valve is connected and immersed in a sterile physiological salt solution. The valve is patent if saline solution can be extracted (Fig. 21).

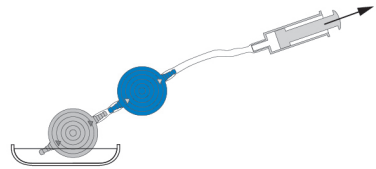

Fig. 21: Patency test

**WARNING**

- ▶ Contaminants in the solution used for testing can impair the product's performance.
- ▶ Pressurisation with a single-use syringe should be avoided both at the proximal and the distal end (Fig. 22).

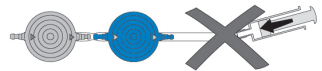

Fig. 22: Avoidance of pressurisation

4.5.5 PERFORMING THE IMPLANTATION**Positioning of the Ventricular Catheter**

Several surgical techniques are available for the positioning of the *Ventricular Catheter*. The required skin incision should be made in form of a lobule pedicled towards the shunting catheter or by a straight skin incision. If a *Burrhole Reservoir* - or a *SPRUNG RESERVOIR* - is used,

the skin incision should not be located right above the reservoir. To avoid CSF leakage, care should be taken that the dura opening is kept as small as possible after applying the burr hole. *M.blue plus* is available in a range of different configurations: If using a *Burrhole Reservoir* - or a *SPRUNG RESERVOIR* -, the *Ventricular Catheter* is implanted first. Once the mandrin has been removed, the patency of the *Ventricular Catheter* can be tested by checking if cerebrospinal fluid is dripping out. The catheter is shortened and the *Burrhole Reservoir* - or the *SPRUNG RESERVOIR* - connected and the connection secured with a ligature.

When using a shunt system with a *CONTROL RESERVOIR*, a *Burrhole Deflector* is included. The *Burrhole Deflector* is used to adjust the length of the catheter to be implanted and to position it inside the ventricle. The *Ventricular Catheter* is deflected by 90° and the *CONTROL RESERVOIR* put into place. The position of the *Ventricular Catheter* should be inspected after the procedure by imaging (such as CT or MRI).

Placement of the valve system

For ventriculoperitoneal shunting, a location behind the ear is suitable as an implantation position, whereby the implantation height has no influence on the valve system function.

The adjustable valves should be touching the bone or the periosteum since pressure must be exerted on the valve during any later adjustment.

A large arch-shaped or a small straight skin cut with a pocket for the valve system should be made. The catheter is pushed forward from the burr hole to the selected valve implantation location, shortened if necessary, and secured to the *M.blue plus* by ligature. The valve system should not be located directly under the skin incision. The valve unit has an arrow in the flow direction (arrow towards distal or downwards). The surface of the valve with the arrow markings points to the outside.



WARNING

- ▶ **The correct flow direction must be strictly observed as per the arrows. Incorrect implantation will result in flow prevention and underdrainage.**



WARNING

- ▶ **During placement, it must be ensured that the adjustable throttle is positioned a maximum of 10 mm below the skin surface to make it easier to locate the throttle as well as to read and adjust the throttle level. If the implantation site is unfavourably chosen or the skin above the throttle is too thick (skin and tissue thickness greater than 10 mm), it may no longer be possible to locate the throttle as well as read and adjust the throttle level. The throttle then works with a fixed throttle level.**
- ▶ **The gravitational unit of the *M.blue plus* is posture-dependent. For that reason, care must be taken to implant the gravitational unit (*M.blue*) parallel to the body axis.**

Therefore, when using a shunt system in which the valve has been pre-fitted with a *Burrhole Reservoir* or a *SPRUNG RESERVOIR*, only the occipital access should be used.

Positioning of the Peritoneal Catheter

The access site for the *Peritoneal Catheter* is left to the surgeon's discretion. For example, it can be used in a paraumbilical application or applied at the level of the epigastrium. Likewise, various surgical techniques are available for placing the *Peritoneal Catheter*.

The recommendation is to pull the *Peritoneal Catheter* from the valve to the intended position using a subcutaneous *Tunneller*, if necessary with the aid of an auxiliary incision. The *Peritoneal Catheter*, usually securely attached to the valve, has an open distal end and no wall slits.

Following the exposure of the peritoneum or with the aid of a trocar, the *Peritoneal Catheter* (shortened if necessary) is pushed forward into the open space of the abdominal cavity.

4.5.6 POSTOPERATIVE TEST

Postoperative valve test

The *M.blue plus* has been constructed as a reliably functioning unit without pump or test function. The valve test can be performed by flushing, pressure measurement or pumping via a *Reservoir* or a *Prechamber*.

4.6 EXPLANTATION AND DISPOSAL

4.6.1 EXPLANTATION

The explantation of the *M.blue plus* should be performed according to the state of the art and in compliance with medical practice.

4.6.2 DISPOSAL

M.blue plus and shunt components

Products and product parts not used in the implantation or surgically removed must be disposed of correctly as potentially infectious material in accordance with medical practice as well as respective regional laws and regulations.

4.7 TECHNICAL INFORMATION

4.7.1 MATERIALS THAT COME INTO CONTACT WITH BODILY TISSUE/ FLUIDS

Quantitative material properties



















All implantable parts of a shunt system with direct contact to body tissues or fluids are bio-compatible and are composed as follows:



- ▶ Titanium alloy $TiAl_6V_4$ (ASTM F136)
- ▶ Titanium grade 1 (ASTM F67)
- ▶ Tantalum (ASTM F560)
- ▶ White sapphire Al_2O_3 (ISO 6474-1)
- ▶ Implant steel 1.4441 (ISO 5832-1)
- ▶ Silicone elastomer (long-term implantable)
- ▶ Polyester ligature

4.7.2 TECHNICAL DATA

Manufacturer	Christoph Miethke GmbH & Co. KG
Product designation	<i>M.blue plus</i>
Medical Purpose	Shunting of cerebrospinal fluid (CSF)
Sterilisability	Cannot be resterilised
Storage	Store in a clean and dry place room temperature
For single use only	
Sketch with outer dimensions:	

4.8 SYMBOLS USED FOR LABELLING

Symbol	Explanation
	EU conformity marking, xxxx indicates the identifier of the responsible notified body
	Medical Device
	Manufacturer
	Date of manufacture
	Use by
	Batch name
	Catalogue number
	Serial number
	Unique Device Identification
UDI-DI	UDI-DI number
	Vapour or dry heat sterilised
	Do not resterilise
	Do not reuse
	Double sterile barrier system
	Do not use if the packaging is damaged; and follow the instructions for use
	Store in a dry place
	Temperature limits
	Consult instructions for use / electronic instructions for use
	Caution

Symbol	Explanation
	Pyrogen-free
	Free of natural rubber latex, latex-free
	Indicates that in the USA, the product may only be issued to physicians.
	MR Conditional
	Patient identification
	During implantation
	Outpatient clinic or physician
	Website with patient information
	Model number / European Medical Device Nomenclature Code

5 MEDICAL DEVICE CONSULTANTS

In compliance with regulatory requirements, Christoph Miethke GmbH & Co. KG has nominated medical device consultants as contacts for all product-related questions. You can contact our medical device consultants at:

Tel. +49 331 62083-0

info@miethke.com



 Technical alterations reserved

Manufacturer:



Christoph Miethke GmbH & Co. KG | Ulanenweg 2 | 14469 Potsdam | Germany
Phone +49 331 620 83-0 | Fax +49 331 620 83-40 | www.miethke.com

注册人: Christoph Miethke GmbH & Co. KG 克里斯托福弥提柯股份有限公司
住所: Ulanenweg 2, 14469 Potsdam, Germany
联系方式: www.miethke.com, info@miethke.com

Distributor:



Aesculap AG | Am Aesculap-Platz | 78532 Tuttlingen | Germany
Phone +49 7461 95-0 | Fax +49 7461 95-2600 | www.bbraun.com

AESCULAP® - a B. Braun brand